

タダノ オールテレーンクレーン

ATF-100G4(J) 型

仕 様 書

形 式 呼 称	A T F - 1 0 0 G 4 (J)
キ ャ リ ヤ	F A U N A T F 9 0 G - 4
ス ペ ッ ク 番 号	A T F - 1 0 0 G - 1 - 9 0 1 0 1

株式会社 タダノ

構成図

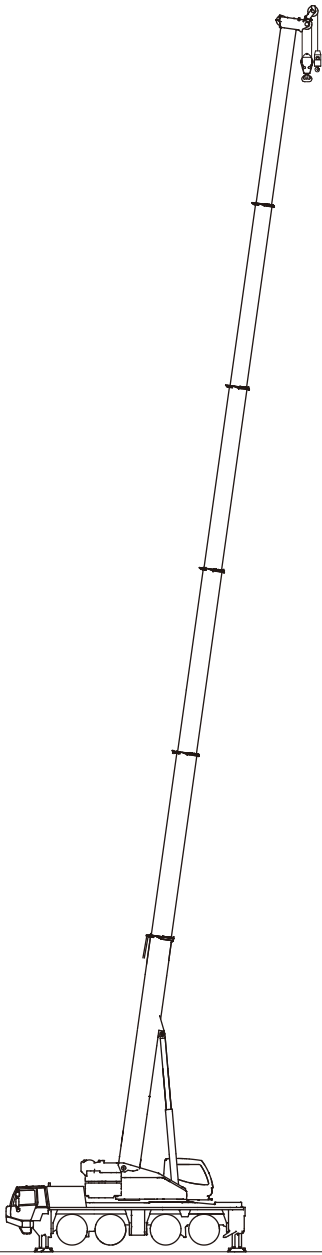

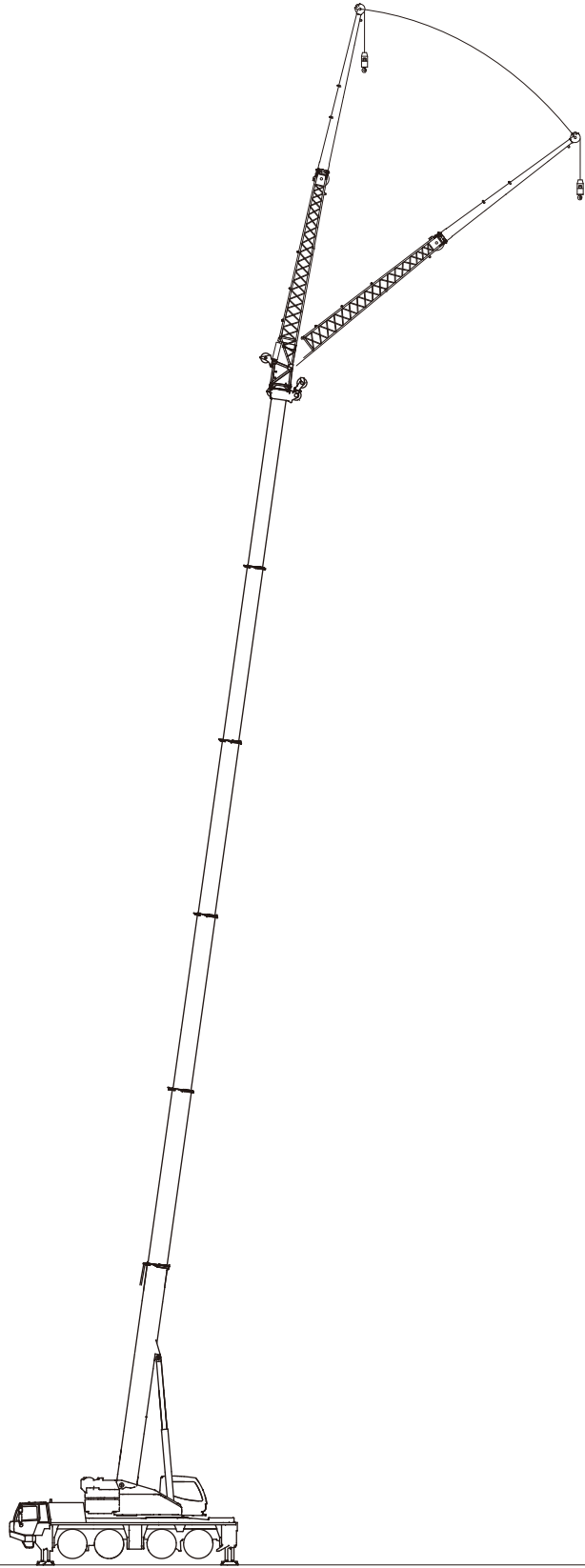

ブーム



油圧チルトジブ
HLJ

カウンタウエイトとアウトリガ張出幅の組合せによって次のように定格総荷重表を選定し該当ページを読み取ってください。

ブーム								
 ブーム	アウトリガ張出幅	カウンタウエイト	25 t	21 t	15 t	9 t	5 t	0 t
	7.2 m	A	B	C	D	E	F	
	6.0 m	G	H	I	J	K	L	
	5.0 m	M	N	O	P	Q	R	
	2.55 m	—	—	—	—	—	—	S,T

ブーム+油圧チルトジブ(HLJ)							
 ブーム HLJ	アウトリガ張出幅	カウンタウエイト	25 t	21 t	15 t	9 t	5 t
	7.2 m	A	B	C	D	E	
	6.0 m	G	H	I	J	K	
	5.0 m	M	N	O	P	Q	

注) 一印の組合せでは、クレーン作業を行わないでください。

諸元

■クレーン

ブーム	11.1m	100,000 kg × 2.3m (2×10本掛、アタッチメント付)
	14.8m	54,600 kg × 4.5m (11本掛)
	18.5m	54,600 kg × 3.5m (11本掛)
	22.1m	45,600 kg × 5.0m (9本掛)
	25.8m	40,900 kg × 4.5m (8本掛)
	29.5m	31,300 kg × 5.0m (6本掛)
	33.2m	23,800 kg × 8.0m (5本掛)
	36.9m	19,700 kg × 9.0m (4本掛)
	40.5m	15,800 kg × 10.0m (3本掛)
	44.2m	12,900 kg × 12.0m (3本掛)
47.9m	10,200 kg × 16.0m (2本掛)	
51.2m	8,900 kg × 16.0m (2本掛)	
シングルトップ	5,600 kg	(1本掛)
油圧チルトジブ (HLJ)	10.0m HLJ	11,000 kg × 8.0m (2本掛)
	18.0m HLJ	5,600 kg × 11.0m (1本掛)
最大地上揚程	ブーム	52.0m (8.9 t)
	HLJ	70.0m (2.7 t)
最大作業半径	ブーム	48.0m (1.7 t)
	HLJ	58.0m (0.6 t)
ブーム・ジブ長	ブーム	11.1m ~ 51.2m
	HLJ	10.0m、18.0m
ブーム・ジブ形	ブーム	箱型6段油圧伸縮式、各段ピンロック方式
	HLJ	ラチス型1段 + 箱型1段 オフセット5° ~ 40° 油圧無段階傾斜式
	シングルトップ	先端ブーム取付横折曲格納式
ブーム伸縮装置	複動油圧シリンダ直押し1本	
ブーム伸長速度	40.1m/290 s	
フック	55 t フック (5枚シーブ) 18 t フック (1枚シーブ) 5.6 t フック	
巻上装置	油圧モータ駆動遊星歯車減速式 自動ブレーキ シングルウインチ 2基	
ワイヤロープ	主巻	径18mm × 長さ265m、非自転性ワイヤロープ
	補巻	径18mm × 長さ230m、非自転性ワイヤロープ
巻上速度	主巻	115m/min (4層)
	補巻	115m/min (4層)
ブーム起伏装置	複動油圧シリンダ直押し 1本	
ブーム上げ速度	-0.5° ~ 82.0° / 30 s	
旋回装置	油圧モータ駆動遊星歯車減速式 ボール式スイングベアリング 手動スイッチ式旋回フリー 手動操作式旋回ロック 手動スイッチ式ブレーキ	
旋回角度	360° 連続	
旋回速度	2.1 min ⁻¹	
カウンタウエイト	25 t、21 t、15 t、9 t、5 t	
アウトリガ	全油圧式 H型 張出幅：最大7.2m、 中間6.0m、5.0m 最小2.55m	
	スライド・ジャッキ各個操作装置付 スライドロック用ピン付 スライド格納式フロート	
	形式	ベンツ OM924LA 水冷4サイクル 直列4気筒 直接噴射式 排気ターボ過給 インタークーラ付 ディーゼルエンジン 尿素SCRシステム付
上部エンジン	総排気量	4.8 L
	最高出力	129kW [175PS] / 2,200min ⁻¹ [rpm]
	最大トルク	675N・m [68kgf・m] / 1,200~1,600min ⁻¹ [rpm]
燃料タンク容量	220 L	
Adblueタンク容量	8 L	
油圧ポンプ	高圧可変ピストンポンプ 2個 高圧ピストンポンプ 1個 高圧ギヤポンプ 1個	

安全装置	過負荷防止装置 (AML) 作業範囲制限機能 フック移動量表示機能 アウトリガ張出幅自動検出装置 (個別検出式) 旋回範囲制限機能 旋回自動停止機能 ブーム起伏緩停止機能 巻上防止装置 捨巻確保装置 水準器 玉掛けロープはずれ止め 旋回ロック装置 油圧安全弁 油圧ロック装置 (伸縮・起伏・巻上・ジャッキ)
付属装置	カウンタウエイト着脱装置 ブーム起伏微速モード設定装置 旋回微速モード設定装置 ジブチルト微速モード設定装置 巻き上げ微速モード設定装置 AML外部表示灯 風速計 オイルクーラー クレーン運転室エアコン ラジオ ドラム視認モニタ 旋回音声警報装置
オプション	拡声器

■キャリヤ

最高速度	85km/h	
登坂能力	tan θ = 0.7	
最小回転半径	8.7m	
全長	13,000mm	
全幅	2,780mm	
全高	3,850mm	
軸距	1,700mm+2,440mm+1,700mm	
輪距	2,350mm	
車両総重量 (公道走行状態)	全重量	39,800kg
	前軸	22,840kg (1軸 + 2軸)
	後軸	16,960kg (3軸 + 4軸)
乗員定員	2名	
エンジン	形式	ベンツ OM501LA、 水冷4サイクルV型6気筒直接噴射式、 インタークーラー付ターボディーゼルエンジン 尿素SCRシステム付
	総排気量	11.946L
	最高出力	320kW [435PS] / 1,800min ⁻¹
	最大トルク	2,100N・m [214kgf・m] / 1,300min ⁻¹
燃料タンク容量	400L	
Adblueタンク容量	40L	
変速機	形式	ZF ASトロニック 自動変速式インターダブレーキ付
	段	前進12段、後進2段
駆動方式	8×4 (6) (2軸) + 3軸 + 4軸、デフロック装置付	
車軸形式	全浮動式	
懸架方式	全軸ハイドロニューマチック、レベリング調整付 サスペンションストローク：+150mm、-50mm	
ステアリング	左ハンドル、非常ステアリングポンプ付2系統式 パワーステアリング、特殊ステアリングモード付	
ブレーキ	主ブレーキ	空気式全輪制動、2系統式、ABS装着
	駐車ブレーキ	2・3・4輪制動スプリング式
	補助ブレーキ	変速機内蔵インターダ、排気ブレーキ
タイヤ	385/95 R25 170F ROAD (全輪)	
バッテリー	12V -170Ah × 2 (24V)	
付属装置	カーエアコン、ラジオ、集中給油装置、 仮眠用ベッド、バックモニタ	

走行

■ 公道走行状態

単位(mm)

● 39.8 t

(公道走行時の注意事項)

1. ジブ・サブウインチ・カウンタウイト装置およびホースリールを別送しなければなりません。
2. 道路運送車両の保安基準による保安基準緩和の認定が必要です。
3. 新規開発車両証明制度による(準)適合証明書の交付を受けていますが、通行条件は経路ごとの道路管理者の算定結果によって付与されます。

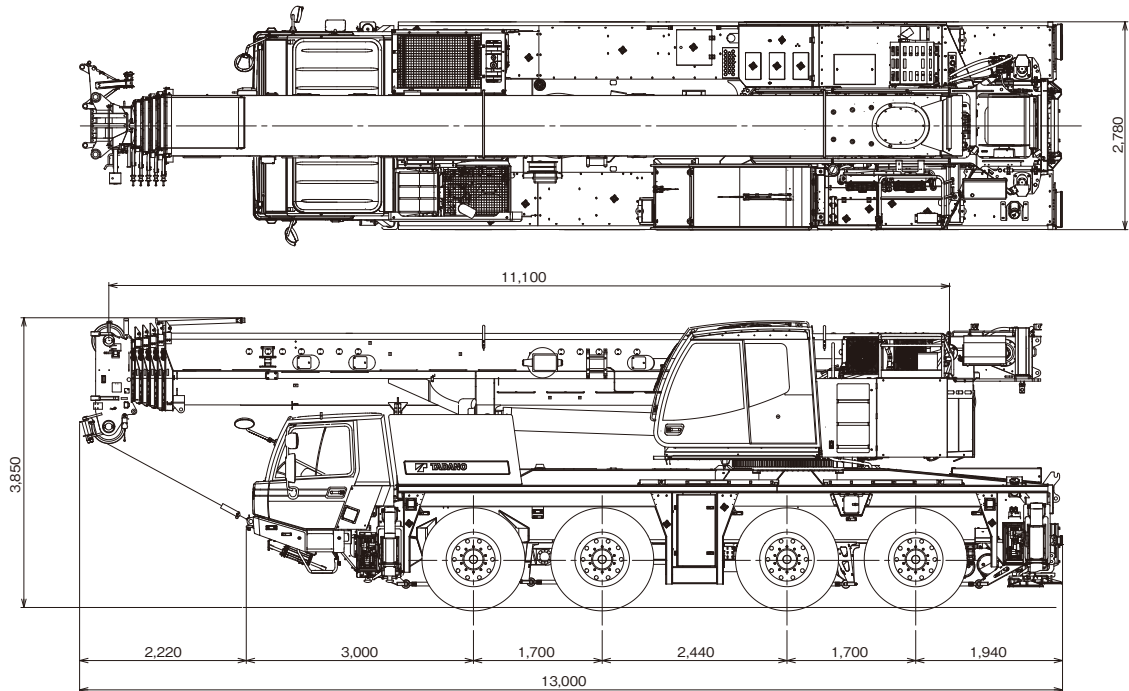

■ 構内移動姿勢

単位(mm)

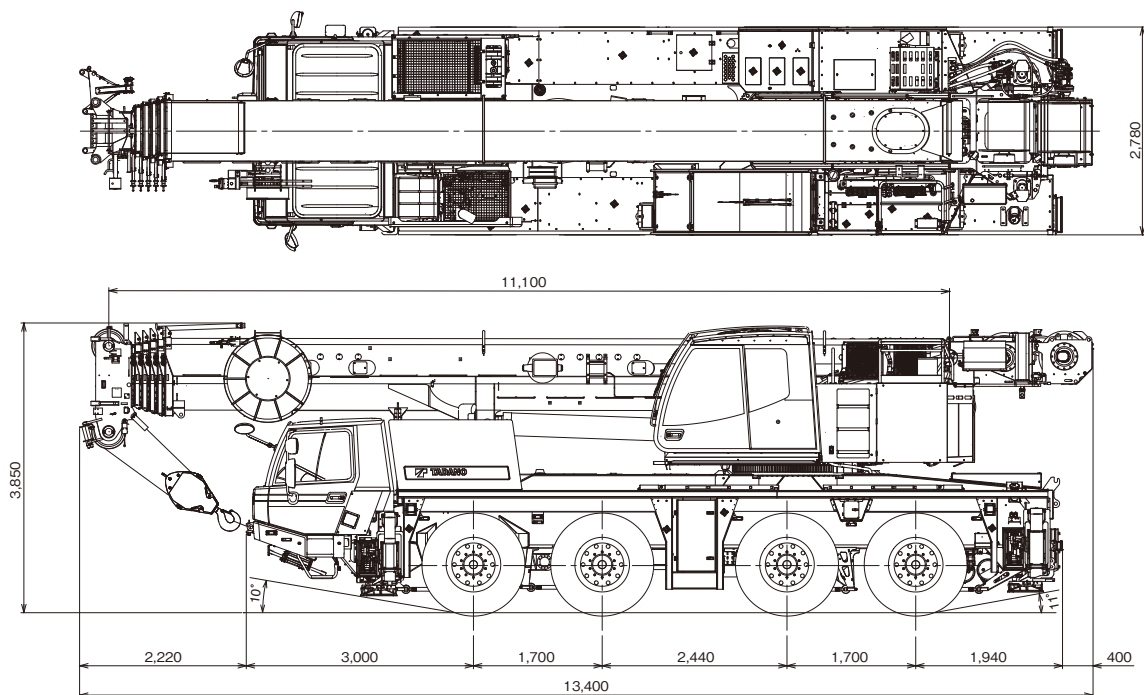

+150mm、-50mm (サスペンション)

最低地上高：220mm

走行

■ 最小直角通路幅

単位(mm)

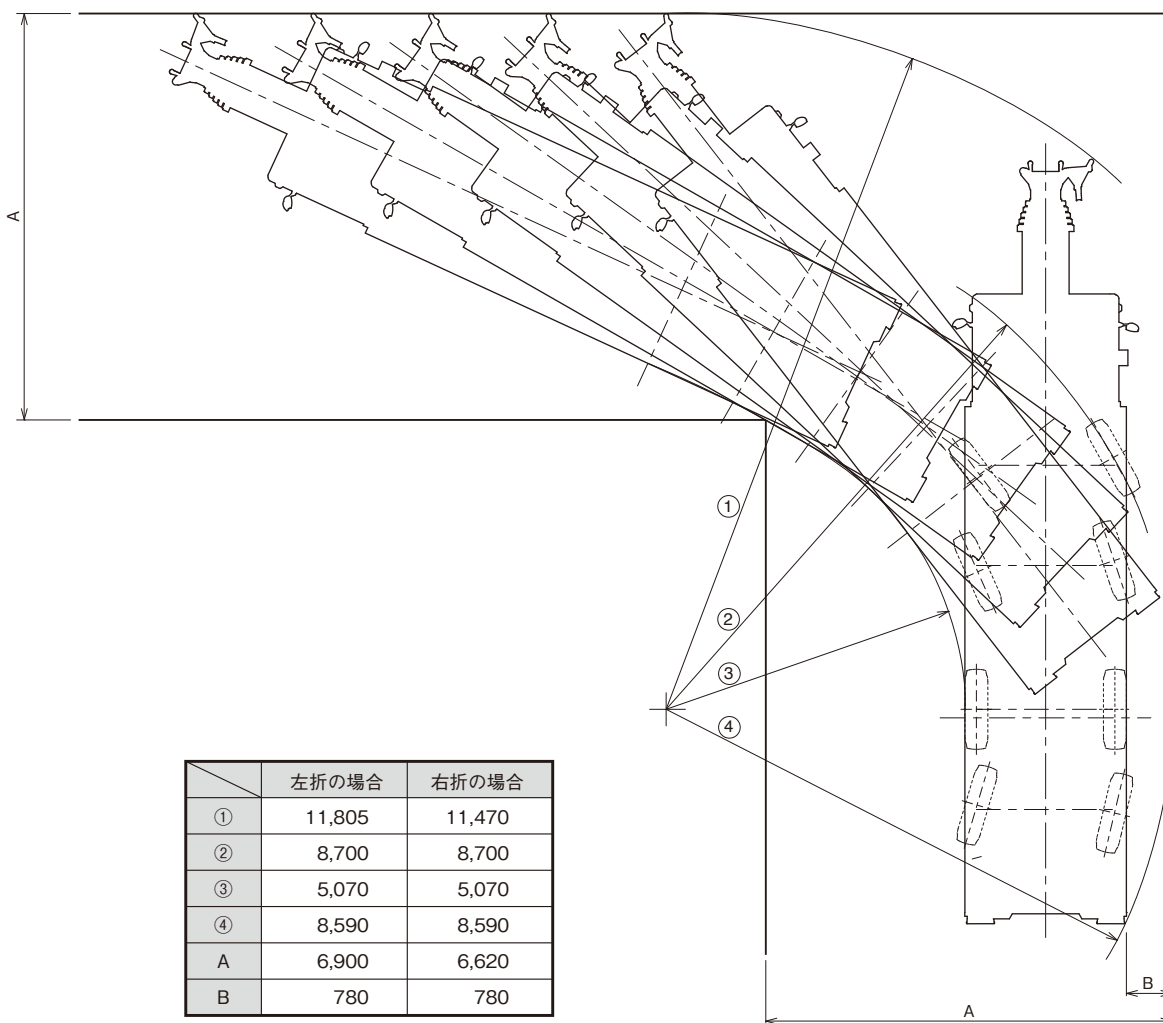

搬 送

■ 分解搬送部品

単位(mm)

● 油圧チルトジブ (HLJ) 1.0 t

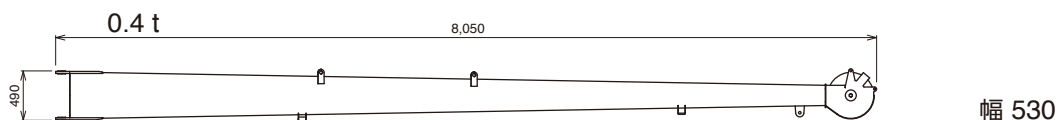
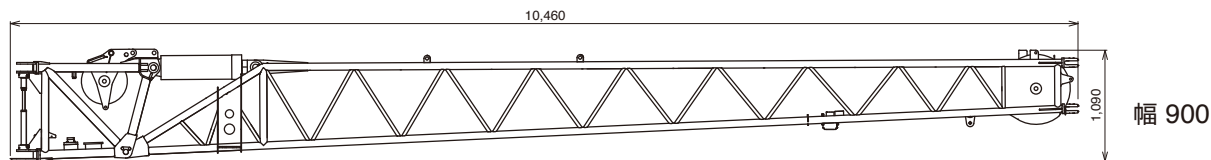

● 補巻ウインチ 1.0 t

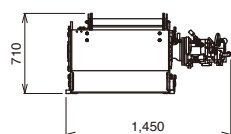

長さ 780

● ホースリール 0.2 t

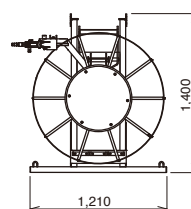

幅 670

● カウンタウエイト (C/W)

① 1.0 t

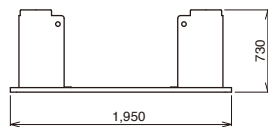

長さ 1,370

② 4.5 t

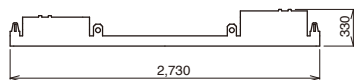

長さ 1,600

③ 2.9 t

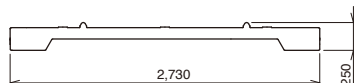

長さ 1,600

④ 1.2 t

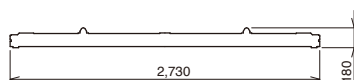

長さ 1,600

⑤ 4.4 t

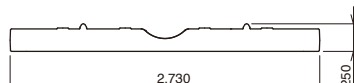

長さ 1,600

⑥ 2.7 t

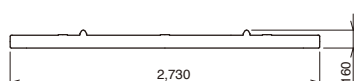

長さ 1,600

⑦ 4.6 t

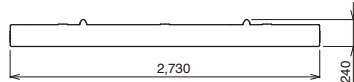

長さ 1,600

⑧ 4.0 t

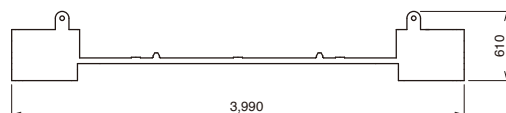

長さ 1,600

● フック

55tフック 0.65 t

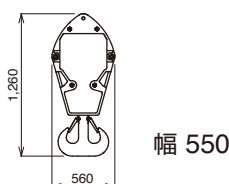

幅 550

18tフック 0.3 t

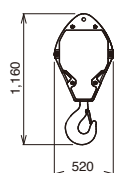

幅 265

5.6tフック 0.15 t

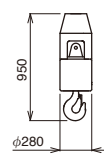

幅 280

● アタッチメントシーブ +アダプタ 0.1 t

+アダプタ 0.1 t

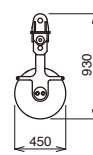

幅 1,210

その他に付属品があります。

設置

■ アウトリガ張出幅・テールスイング

単位(mm)

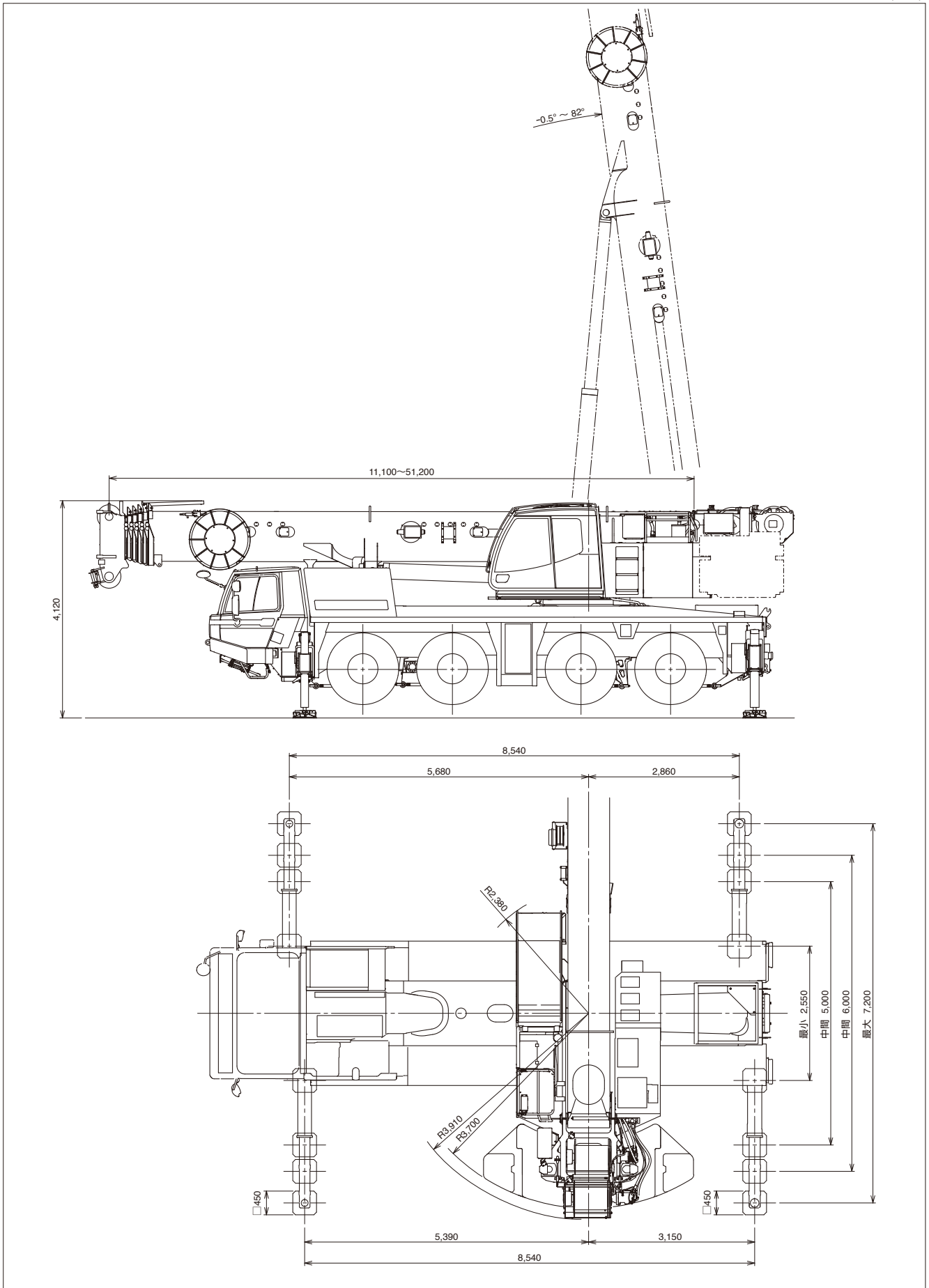

設 置

■ フック寸法

単位(mm)

H: ヘッドシーブ中心とハッカ上面の距離

	55tフック	18tフック	5.6tフック
ブーム	2.0m	2.0m	
シングルトップ			2.8m
10m ジブ		2.9m	3.0m
18m ジブ			2.8m

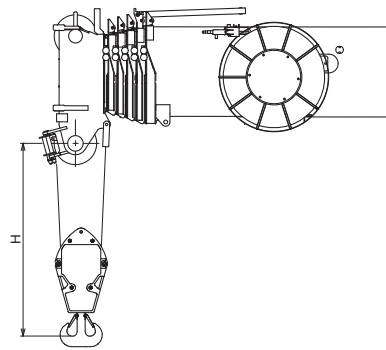

■ カウンタウエイト(C/W)組合せ

● 各ウエイトの使用個数を示す

重量 呼称(実重量)	ウエイト ① 1.0t	ウエイト ② 4.5t	ウエイト ③ 2.9t	ウエイト ④ 1.2t	ウエイト ⑤ 4.4t	ウエイト ⑥ 2.7t	ウエイト ⑦ 4.6t	ウエイト ⑧ 4.0t
25 t (25.3 t)	1	1	1	1	1	1	1	1
21 t (21.3 t)	1	1	1	1	1	1	1	
15 t (15.5 t)	1	1	1		1	1		
9 t (9.6 t)	1	1	1	1				
5 t (5.5 t)	1	1						

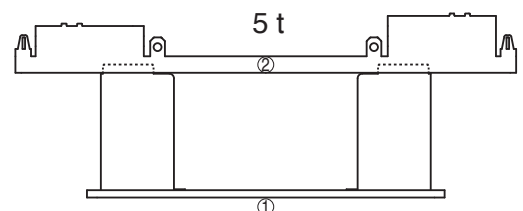
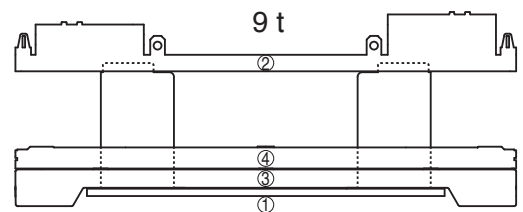
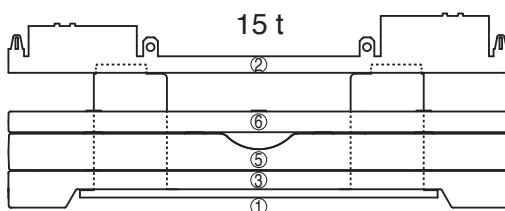
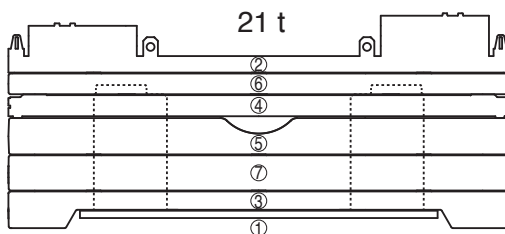
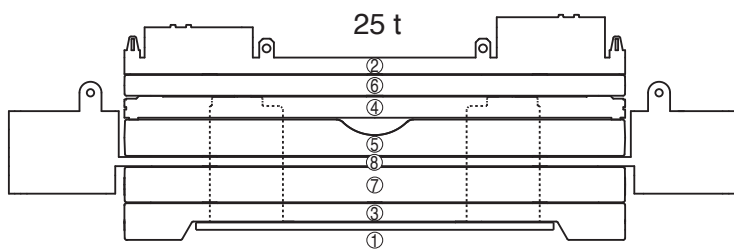

ブーム

ブーム作業半径－揚程図

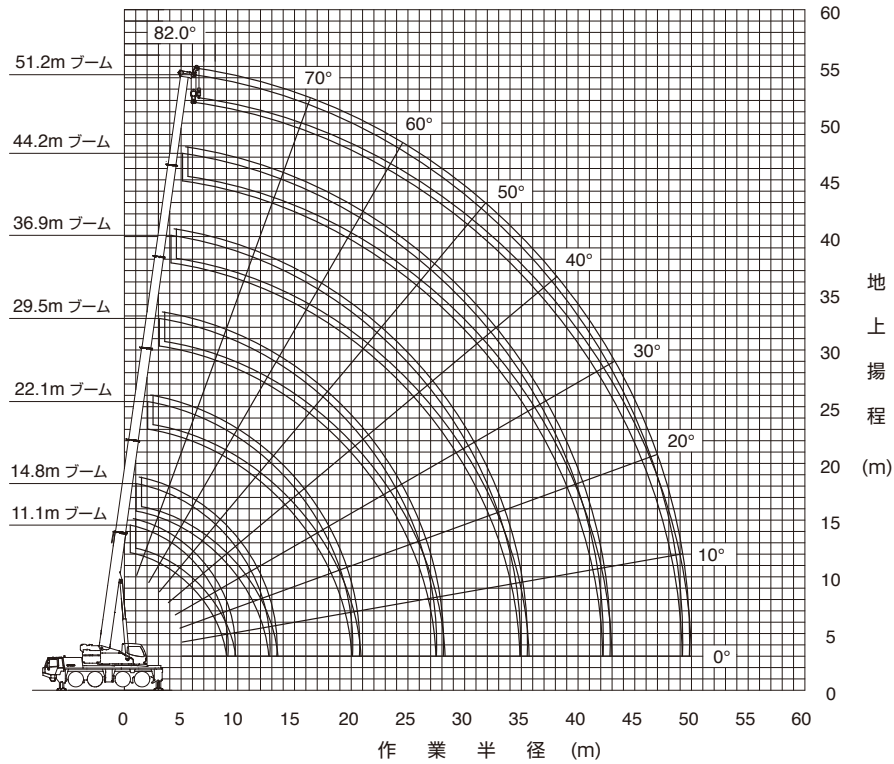

- (注) 1. 上図はブームのたわみを含んでいません。
2. A性能を図示しています。

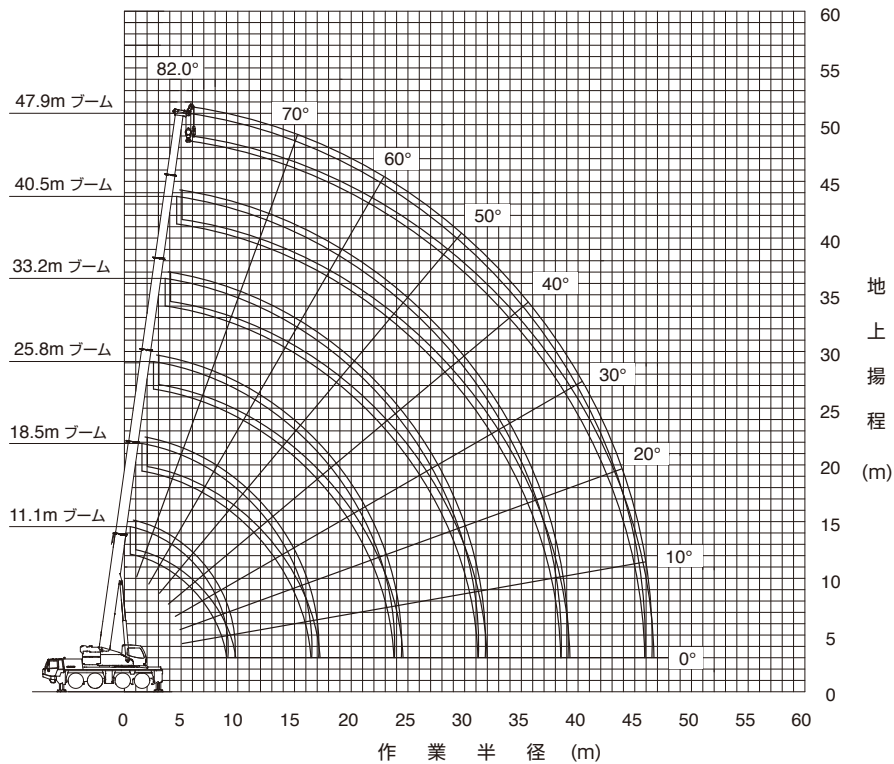

- (注) 1. 上図はブームのたわみを含んでいません。
2. A性能を図示しています。

ブーム定格総荷重表

■ 定格総荷重表注意事項

◆ 定格総荷重表の性能区分A～Tは、下表のとおりです。

アウトリガ張出幅	カウンタウエイト	25 t	21 t	15 t	9 t	5 t	0 t
7.2 m		A	B	C	D	E	F
6.0 m		G	H	I	J	K	L
5.0 m		M	N	O	P	Q	R
2.55 m							S、T

※ 同じ性能区分・ブーム長さでも、ブームの伸長状態によって定格総荷重が異なります。

※ S,T性能は22.1mブームまでで、作業領域は図のようになります。

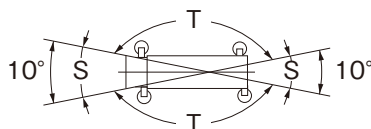

◆ 定格総荷重は、つり具質量とフック質量(55tフック:650kg, 18tフック:300kg, 5.6tフック:150kg)を含んだ値を示します。

◆ 定格総荷重は、ブームのたわみを含んだ実際の作業半径に基づいています。

◆ 定格総荷重表中の標準巻掛本数より少ない本数で使用する場合、最大荷重の上限は下表のとおりです。

巻掛本数	11本	10本	9本	8本	7本	6本	5本	4本	3本	2本	1本
最大荷重	54.6t	50.2t	45.6t	40.9t	36.1t	31.3t	26.3t	21.3t	16.1t	11.0t	5.6t

◆ シングルトップ使用時の巻掛本数は1本(5.6tフック使用)で、定格総荷重はブームの定格総荷重からブームに取り付けられているフックの質量を差し引いた値とし、かつ上限は5.6tです。

◆ 定格総荷重はアウトリガを水平堅土上に設置したときの値です。

◆ 定格総荷重表は、風による影響を含んでいません。瞬間最大風速が10m/s以上の風速では、クレーン作業を中止してください。

定格総荷重表中の線、および用語説明

◆ 太線より上側はクレーンの強度に、下側はクレーンの安定に基づいています。

◆ 「ピン無最大荷重」は、Bピン(ブーム固定ピン)を挿入していないときの定格総荷重の上限を示します。

◆ 「 θ° 」は、無負荷状態で作動可能なブーム起伏角度範囲を示します。

◆ 「主巻時・標準巻掛本数」は、主巻使用時の標準巻掛本数を示します。

◆ 「補巻時・標準巻掛本数」は、補巻使用時の標準巻掛本数を示し、主巻よりもワイヤロープ長さが短いため、巻掛本数が少なくなる場合があります。

◆ 「補巻時・最大荷重」は補巻使用時の定格総荷重の上限を示します。

【C性能】
ブーム

		単位:t																															
性能ブロック	性能番号	1	9	1	9	10	2	1	10	11	2	1	11	2	1	12	2	1	2	3	1	5	4	1	6	1	7	1	1	8			
ブーム長さ(m)	作業半径(m)	1	23	2	24	25	12	3	26	27	13	4	28	14	5	29	15	6	16	17	7	19	18	8	20	9	21	10	11	22			
2.5	54.6																																
3.0	54.6	54.6	35.0	54.6	50.0	35.0	29.9																										
3.5	54.6	54.6	35.0	54.6	50.0	35.0	27.8	45.6	45.6	35.0	29.3																						
4.0	54.6	54.6	35.0	53.9	50.0	35.0	26.0	45.6	45.6	35.0	27.6	40.9	34.2	25.3																			
4.5	54.6	54.6	33.7	49.8	50.0	35.0	24.4	45.6	45.6	35.0	26.1	40.9	34.2	24.2																			
5.0	53.4	53.1	32.0	46.3	50.0	34.8	22.9	42.7	45.6	35.0	24.7	38.8	34.2	23.1	31.3	28.5	22.0																
6.0	45.5	45.1	29.1	40.4	45.3	32.0	20.6	37.2	44.8	33.7	22.4	34.6	34.2	21.2	31.1	28.5	21.1	23.8	20.9	17.3													
7.0	39.0	38.6	26.8	35.9	38.7	29.6	18.6	32.6	39.0	31.5	20.5	31.1	32.7	19.2	28.7	28.5	19.7	23.8	20.9	17.3	19.7	16.1	14.8	15.8	12.9								
8.0	33.7	33.0	24.8	32.1	33.2	27.6	17.0	29.3	33.7	29.5	18.9	27.7	30.8	17.2	26.1	28.5	18.3	23.8	20.9	16.2	19.7	16.1	14.8	15.8	12.9	12.9	11.0						
9.0	23.3	26.7	23.2	26.1	26.9	25.9	15.7	26.4	27.3	27.0	17.5	24.9	29.0	15.6	23.9	28.5	17.0	22.1	20.6	15.1	19.7	16.1	14.8	15.8	12.9	12.9	11.0	10.2					
10.0		22.1	21.8	21.6	22.3	24.1	14.5	21.9	22.8	24.6	16.3	22.3	24.3	14.3	21.9	23.9	15.5	20.7	19.5	14.1	18.5	16.1	14.1	15.8	12.9	12.9	11.0	10.2	8.9				
11.0		18.8	20.5	18.3	18.9	21.0	13.4	18.5	19.3	21.1	15.1	18.9	20.8	13.2	19.5	20.5	14.2	19.2	18.5	13.2	17.4	15.4	13.3	15.6	12.9	12.9	11.0	10.2	8.9				
12.0		16.0	17.8	15.5	16.2	18.3	12.5	15.7	16.6	18.4	14.0	16.2	18.1	12.2	16.7	17.7	13.1	17.3	17.6	12.1	16.4	14.6	12.6	14.8	12.6	12.9	11.0	10.2	8.9				
14.0				11.6	12.2	14.2	11.1	11.8	12.6	14.2	12.3	12.2	14.0	10.6	12.7	13.6	11.4	13.2	14.1	10.4	13.2	13.3	11.4	13.3	11.5	12.2	11.0	10.2	8.9				
16.0				8.9	9.5	11.4	10.0	9.1	9.9	11.4	10.9	9.5	11.2	9.3	10.0	10.9	10.0	10.5	11.3	9.1	10.5	11.5	10.3	10.6	10.5	10.8	10.6	10.2	8.9				
18.0								7.2	7.9	9.4	9.8	7.5	9.2	8.3	8.0	8.8	8.9	8.5	9.3	8.1	8.5	9.5	9.2	8.6	9.6	8.8	9.4	9.1	8.7				
20.0								5.7	6.5	7.9	8.3	6.0	7.7	7.5	6.5	7.3	8.0	7.0	7.7	7.2	6.9	7.9	8.2	7.1	8.0	7.3	7.8	7.6	7.6				
22.0												4.9	6.5	6.8																			
24.0																																	
26.0																																	
28.0																																	
30.0																																	
32.0																																	
34.0																																	
36.0																																	
38.0																																	
40.0																																	
42.0																																	
44.0																																	
46.0																																	
48.0																																	
ピン無最大荷重	21.5	21.8	23.0	17.6	21.4	27.6	15.4	17.7	20.1	21.3	22.3	17.8	20.3	16.3	18.0	18.8	20.3	17.3	18.4	16.1	18.3	16.1	14.8	15.8	12.9	12.9	11.0	10.2	8.9				
θ(°)	0~82	0~82		0~82				0~82				0~82			0~82			0~82			0~82			0~82			0~82			0~82			
伸長状態(伸長割合%)																																	
伸縮ブーム1	0	46	0	92	46	0	0	92	46	0	0	92	0	0	92	46	0	92	46	0	92	46	0	92	46	0	92	46	92	46	92	100	
伸縮ブーム2	0	0	0	0	46	0	0	46	46	0	0	46	46	0	46	46	0	46	46	0	46	46	0	46	46	0	46	46	92	92	92	100	
伸縮ブーム3	0	0	0	0	0	0	0	0	46	46	0	46	46	0	46	46	0	46	46	46	46	92	46	46	92	92	92	92	92	92	92	100	
伸縮ブーム4	0	0	0	0	0	46	0	0	46	46	0	46	46	0	46	46	92	46	46	92	46	46	92	46	92	92	92	92	92	92	92	100	
伸縮ブーム5	0	0	46	0	0	46	92	0	0	46	92	0	46	92	0	46	92	0	46	92	46	92	46	92	46	92	46	92	46	92	92	100	
標準フック重量	55t	55t		55t				55t				55t			55t			55t			55t			18t		18t		18t		18t		18t	
フック重量	650kg	650kg		650kg				650kg				650kg			650kg			650kg			650kg			300kg		300kg		300kg		300kg		300kg	
主巻時標準巻掛本数	11	11	7	11	10	7	6	9	7	6	8	7	5	6	5	5	4	4	4	3	3	3	3	3	2	2	2	2	2	2			
補巻時標準巻掛本数	11	11	7		9	7	6	8	7	6	6	5	6	5	5	4	4	3	3	3	3	3	3	2	2	2	2	2	2	2			
補巻時最大荷重	54.6	54.6	35.0	45.6	35.0	29.9		40.9	35.0	29.3		31.3	25.3		31.3	28.5	22.0	23.8	20.9	17.3	19.7	16.1	14.8	15.8	12.9	12.9	11.0	10.2	8.9				

注)カウンタウエイト 15t、アウトリガ張出幅 7.2m

【D性能】
ブーム

		単位:t																														
性能ブロック	性能番号	1	9	1	9	10	2	1	10	11	2	1	11	2	1	12	2	1	2	3	1	5	4	1	6	1	7	1	1	8		
ブーム長さ(m)	作業半径(m)	1	23	2	24	25	12	3	26	27	13	4	28	14	5	29	15	6	16	17	7	19	18	8	20	9	21	10	11	22		
2.5	54.6																															
3.0	54.6	54.6	35.0	54.6	50.0	35.0	29.9																									
3.5	54.6	54.6	35.0	54.6	50.0	35.0	27.8	45.6	45.6	35.0	29.3																					
4.0	54.6	54.6	35.0	53.9	50.0	35.0	26.0	45.6	45.6	35.0	27.6	40.9	34.2	25.3																		
4.5	54.6	54.6	33.7	49.8	50.0	35.0	24.4	45.6	45.6	35.0	26.1	40.9	34.2	24.2																		
5.0	52.5	52.1	32.0	46.3	50.0	34.8	22.9	42.7	45.6	35.0	24.7	38.8	34.2	23.1	31.3	28.5	22.0															
6.0	43.9	43.5	29.1	40.4	43.7	32.0	20.6	37.2	44.8	33.7	22.4	34.6	34.2	21.2	31.1	28.5	21.1	23.8	20.9	17.3												
7.0	36.4	35.6	26.8	35.0	35.9	29.6	18.6	32.6	39.0	31.5	20.5	31.1	32.7	19.2	28.7	28.5	19.7	23.8	20.9	17.3	19.7	16.1	14.8	15.8	12.9							
8.0	28.3	27.5	24.8	26.9	27.7	27.6	17.0	27.2	28.2	29.5	18.9	27.7	30.0	17.2	26.1	28.5	18.3	23.8	20.9	16.2	19.7	16.1	14.8	15.8	12.9	12.9	11.0					
9.0	22.8	22.0	23.2	21.4	22.2	24.6	15.7	21.7	22.7	24.7	17.5	22.2	24.4	15.6	22.9	24.0																

【G性能】
ブーム

Table with columns for boom length (11.1, 14.8, 18.5, 22.1, 25.8, 29.5, 33.2, 36.9, 40.5, 44.2, 47.9, 51.2) and rows for boom height (2.5 to 48.0) and performance metrics (最大荷重, θ, etc.).

注)カウンタウエイト 25t、アウトリガ張出幅 6.0m

【H性能】
ブーム

Table with columns for boom length (11.1, 14.8, 18.5, 22.1, 25.8, 29.5, 33.2, 36.9, 40.5, 44.2, 47.9, 51.2) and rows for boom height (2.5 to 48.0) and performance metrics (最大荷重, θ, etc.).

注)カウンタウエイト 21t、アウトリガ張出幅 6.0m

ブーム

【I性能】

ブーム

単位:t

性能ブロック	1	9	1	9	10	2	1	10	11	2	1	11	2	1	12	2	1	2	3	1	5	4	1	6	1	7	1	1	8					
性能番号	1	23	2	24	25	12	3	26	27	13	4	28	14	5	29	15	6	16	17	7	19	18	8	20	9	21	10	11	22					
ブーム長さ(m)	11.1	14.8			18.5			22.1					25.8			29.5			33.2			36.9			40.5		44.2		47.9	51.2				
作業半径(m)	2.5	54.6																																
2.5	54.6																																	
3.0	54.6	54.6	35.0	54.6	50.0	35.0	29.9																											
3.5	54.6	54.6	35.0	54.6	50.0	35.0	27.8	45.6	45.6	35.0	29.3																							
4.0	54.6	54.6	35.0	53.9	50.0	35.0	26.0	45.6	45.6	35.0	27.6	40.9	34.2	25.3																				
4.5	54.6	54.6	33.7	49.8	50.0	35.0	24.4	45.6	45.6	35.0	26.1	40.9	34.2	24.2																				
5.0	52.3	51.9	32.0	46.3	50.0	34.8	22.9	42.7	45.6	35.0	24.7	38.8	34.2	23.1	31.3	28.5	22.0																	
6.0	43.3	43.4	29.1	40.4	43.5	32.0	20.6	37.2	43.9	33.7	22.4	34.6	34.2	21.2	31.1	28.5	21.1	23.8	20.9	17.3														
7.0	35.9	35.1	26.8	34.5	35.3	29.6	18.6	32.8	35.9	31.5	20.5	31.1	32.7	19.2	28.7	28.5	19.7	23.8	20.9	17.3	19.7	16.1	14.8	15.8	12.9									
8.0	27.8	27.1	24.8	26.5	27.3	27.6	17.0	26.8	27.8	29.5	18.9	27.3	29.6	17.2	26.1	28.5	18.3	23.8	20.9	16.2	19.7	16.1	14.8	15.8	12.9	12.9	11.0							
9.0	22.5	21.7	23.2	21.2	21.9	24.2	15.7	21.5	22.4	24.3	17.5	21.9	24.1	15.6	22.6	23.7	17.0	22.1	20.6	15.1	19.7	16.1	14.8	15.8	12.9	12.9	11.0	10.2						
10.0	17.9	19.7	17.4	18.1	20.3	14.5	17.7	18.5	20.4	16.3	18.1	20.1	14.3	18.7	19.7	15.5	19.3	19.5	14.1	18.5	16.1	14.1	15.8	12.9	12.9	11.0	10.2	8.9						
11.0	15.1	16.8	14.6	15.3	17.3	13.4	14.8	15.7	17.4	15.1	15.3	17.2	13.2	15.8	16.8	14.2	16.4	17.3	13.2	16.4	15.4	13.3	15.6	12.9	12.9	11.0	10.2	8.9						
12.0	12.9	14.5	12.4	13.0	15.0	12.5	12.6	13.4	15.1	14.0	13.0	14.9	12.2	13.6	14.5	13.1	14.1	15.0	12.1	14.1	14.6	12.6	14.3	12.6	12.9	11.0	10.2	8.9						
14.0			9.2	9.8	11.7	11.1	9.4	10.2	11.7	12.2	9.8	11.5	10.6	10.3	11.2	11.4	10.8	11.6	10.4	10.8	11.9	11.4	11.0	11.5	11.2	11.0	10.2	8.9						
16.0			7.0	7.6	9.4	9.4	7.2	7.9	9.4	9.9	7.5	9.2	9.3	8.0	8.9	10.0	8.5	9.3	9.1	8.5	9.5	9.9	8.7	9.6	8.9	9.4	9.2	8.9						
18.0							5.6	6.3	7.7	8.2	5.9	7.5	8.2	6.4	7.2	8.3	6.8	7.6	8.1	6.8	7.8	8.1	7.0	7.9	7.2	7.7	7.5	7.5						
20.0							4.4	5.1	6.5	6.9	4.7	6.3	6.9	5.1	5.9	7.0	5.6	6.3	6.9	5.5	6.5	6.8	5.7	6.6	5.9	6.4	6.2	6.2						
22.0											3.7	5.3	5.9				3.3	4.1	5.1	3.7	4.5	5.0	3.7	4.6	4.9	3.9	4.7	4.0	4.5	4.3				
24.0																	3.3	4.1	5.1	3.7	4.5	5.0	3.7	4.6	4.9	3.9	4.7	4.0	4.5	4.3				
26.0																	2.7	3.5	4.4				3.1	3.8	4.3	3.1	4.0	3.3	3.6	3.6				
28.0																							2.5	3.2	3.7	2.5	3.4	3.7	2.6	3.5	3.1			
30.0																							2.1	2.8	3.3	2.0	2.9	3.2	2.1	3.0	2.3	2.6	2.6	
32.0																							1.6	2.5	2.8	1.7	2.6	1.9	2.4	2.2	2.1			
34.0																							1.2	2.1	2.4	1.3	2.2	1.5	2.0	1.8	1.8			
36.0																																		
38.0																																		
40.0																																		
42.0																																		
ピン無最大荷重	21.5	21.8	23.0	17.6	21.4	27.6	15.4	17.7	20.1	21.3	22.3	17.8	20.3	16.3	18.0	18.8	20.3	17.3	18.4	16.1	18.3	16.1	14.8	15.8	12.9	12.9	11.0	10.2	8.9					
θ(°)	0~82	0~82		0~82				0~82				0~82			0~82			0~82			0~82			0~82		0~82		0~82		0~23	~82	82		
伸長状態(伸長割合)																																		
伸縮ブーム1	0	46	0	92	46	0	0	92	46	0	0	92	0	0	92	46	0	92	46	0	92	46	0	92	46	0	92	46	92	100				
伸縮ブーム2	0	0	0	0	46	0	0	46	46	0	0	46	46	0	46	46	0	46	46	0	46	46	0	46	46	0	46	46	92	92	100			
伸縮ブーム3	0	0	0	0	0	0	0	0	46	46	0	46	46	0	46	46	0	46	46	0	46	46	0	46	46	0	46	46	92	92	100			
伸縮ブーム4	0	0	0	0	0	46	0	0	0	46	46	0	46	46	0	46	46	0	46	46	0	46	46	0	46	46	0	46	46	92	92	100		
伸縮ブーム5	0	0	46	0	0	46	92	0	0	46	92	0	0	46	92	0	46	92	0	46	92	0	46	92	0	46	92	0	46	92	92	100		
標準フック	55t	55t		55t				55t				55t			55t			55t			55t			55t	18t	18t	18t	18t	18t	18t	18t			
フック重量	650kg	650kg		650kg				650kg				650kg			650kg			650kg			650kg			650kg	300kg	300kg	300kg	300kg	300kg	300kg	300kg			
主巻時標準巻掛本数	11	11	7	11	10	7	6	9	7	6	8	7	5	6	6	5	5	5	4	4	3	3	3	3	3	2	2	2	2	2				
補巻時標準巻掛本数	11	11	7	9	7	6	8	7	6	6	6	5	6	5	5	5	4	4	3	3	3	3	3	3	2	2	2	2	2	2				
補巻時最大荷重	54.6	54.6	35.0	45.6	35.0	29.9	40.9	35.0	29.3	31.3	25.3	31.3	28.5	22.0	23.8	20.9	17.3	19.7	16.1	14.8	15.8	12.9	12.9	11.0	10.2	8.9								

注)カウンタウエイト 15t、アウトリガ張出幅 6.0m

【J性能】

ブーム

単位:t

性能ブロック	1	9	1	9	10	2	1	10	11	2	1	11	2	1	12	2	1	2	3	1	5	4	1	6	1	7	1	1	8	
性能番号	1	23	2	24	25	12	3	26	27	13	4	28	14	5	29	15	6	16	17	7	19	18	8	20	9	21	10	11	22	
ブーム長さ(m)	11.1	14.8			18.5			22.1					25.8			29.5			33.2			36.9			40.5		44.2		47.9	51.2
作業半径(m)	2.5	54.6																												
2.5	54.6																													
3.0	54.6	54.6	35.0	54.6	50.0	35.0	29.9																							
3.5	54.6	54.6	35.0	54.6	50.0	35.0	27.8	45.6	45.6	35.0	29.3																			
4.0	54.6	54.6	35.0	53.9	50.0	35.0	26.0	45.6	45.6	35.0	27.6	40.9	34.2	25.3																
4.5	54.6	54.6	33.7	49.8	50.0	35.0	24.4	45.6	45.6	35.0	26.1	40.9	34.2	24.2																
5.0	50.3	49.8	32.0	46.3	50.0	34.8	22.9	42.7	45.6	35.0	24.7	38.8	34.2	23.1	31.3	28.5	22.0													
6.0	40.2	39.4	29.1	38.6	39.6	32.0	20.6	37.2	40.3	33.7	22.4	34.6	34.2	21.2	31.1	28.5	21.1	23.8	20.9	17.3										
7.0	29.1	28.3	26.8	27.6	28.5	29.6	18.6	28.0	29.1	31.4	20.5	28.5	31.1	19.2	28.7	28.5	19.7	23.8	20.9	17.3	19.7	16.1	14.8	15.8	12.9					
8.0	22.4	21.6	23.7	21.0	21.8	24.3	17.0	21.3	22.3	24.4	18.9	21.8	24.1	17.2	22.5	23.7	18.3	23.2	20.9	16.2	19.7	16.1	14.8	15.8	12.9	12.9	11.0	10.2		
9.0	17.9	17.2	19.1	16.7	17.4	19.7	15.7	16.9	17.8	19.8	17.5	17.4	19.5	15.6	18.0	19.1	17.0	18.7	19.7	15.1	18.7	16.1	14.8	15.8	1					

ブーム

【M性能】

ブーム

単位:t

性能ブロック	1	9	1	9	10	2	1	10	11	2	1	11	2	1	12	2	1	2	3	1	5	4	1	6	1	7	1	1	8		
性能番号	1	23	2	24	25	12	3	26	27	13	4	28	14	5	29	15	6	16	17	7	19	18	8	20	9	21	10	11	22		
ブーム長さ(m)	11.1	14.8			18.5			22.1				25.8			29.5			33.2			36.9			40.5			44.2			47.9	51.2
作業半径(m)	2.5	54.6																													
3.0	54.6	54.6	35.0	54.6	50.0	35.0	29.9																								
3.5	54.6	54.6	35.0	54.6	50.0	35.0	27.8	45.6	45.6	35.0	29.3																				
4.0	54.6	54.6	35.0	53.9	50.0	35.0	26.0	45.6	45.6	35.0	27.6	40.9	34.2	25.3																	
4.5	53.3	52.9	33.7	49.8	50.0	35.0	24.4	45.6	45.6	35.0	26.1	40.9	34.2	24.2																	
5.0	48.9	48.5	32.0	46.3	48.6	34.8	22.9	42.7	45.6	35.0	24.7	38.8	34.2	23.1	31.3	28.5	22.0														
6.0	41.9	41.4	29.1	40.4	41.6	32.0	20.6	37.2	41.9	33.7	22.4	34.6	34.2	21.2	31.1	28.5	21.1	23.8	20.9	17.3											
7.0	36.3	35.5	26.8	35.0	35.7	29.6	18.6	32.8	36.2	31.5	20.5	31.1	32.7	19.2	28.7	28.5	19.7	23.8	20.9	17.3	19.7	16.1	14.8	15.8	12.9						
8.0	28.9	28.2	24.8	27.6	28.4	27.6	17.0	27.9	28.8	29.5	18.9	27.7	30.5	17.2	26.1	28.5	18.3	23.8	20.9	16.2	19.7	16.1	14.8	15.8	12.9	12.9	11.0				
9.0	23.3	23.1	23.2	22.6	23.3	25.4	15.7	22.8	23.7	25.5	17.5	23.3	25.2	15.6	23.8	24.8	17.0	22.1	20.6	15.1	19.7	16.1	14.8	15.8	12.9	12.9	11.0	10.2			
10.0	19.3	21.0	18.9	19.5	21.5	14.5	18.1	19.9	21.6	16.3	16.3	19.5	21.4	14.3	20.1	21.0	15.5	20.6	19.5	14.1	18.5	16.1	14.1	15.8	12.9	12.9	11.0	10.2	8.9		
11.0	16.5	18.1	16.0	16.7	18.6	13.4	16.3	17.0	18.7	15.1	16.7	18.5	13.2	17.2	18.1	14.2	17.7	18.5	13.2	17.4	15.4	13.3	15.6	12.9	12.9	11.0	10.2	8.9			
12.0	14.3	15.8	13.8	14.4	16.3	12.5	14.0	14.8	16.3	14.0	14.4	16.1	12.2	14.9	15.8	13.1	15.4	16.3	12.1	15.4	14.6	12.6	14.8	12.6	12.9	11.0	10.2	8.9			
14.0			10.5	11.1	12.9	11.1	10.7	11.4	12.9	12.3	11.1	12.7	10.6	11.5	12.4	11.4	12.0	12.8	10.4	12.0	13.0	11.4	12.2	11.5	12.2	11.0	10.2	8.9			
16.0			8.2	8.8	10.5	10.0	8.4	9.1	10.5	10.9	8.7	10.3	9.3	9.2	10.0	10.0	9.6	10.4	9.1	9.6	10.6	10.3	9.8	10.5	10.0	10.5	10.2	8.9			
18.0							6.7	7.4	8.8	9.2	7.0	8.5	8.3	7.4	8.2	8.9	7.9	8.6	8.1	7.9	8.8	9.1	8.0	8.9	8.2	8.7	8.5	8.5			
20.0							5.4	6.1	7.4	7.8	5.7	7.2	7.5	6.1	6.9	7.9	6.5	7.2	7.2	6.5	7.4	7.7	6.6	7.5	6.8	7.3	7.1	7.1			
22.0											4.6	6.1	6.7	5.0	5.8	6.5	6.2	6.5	6.4	6.3	6.6	6.4	5.7	6.6	6.4	6.0	6.0	6.0			
24.0														4.2	4.9	5.9	4.6	5.3	5.8	4.5	5.4	5.7	4.7	5.5	4.9	5.4	5.1	5.1			
26.0																3.5	4.2	5.2	3.8	4.5	5.0	3.8	4.7	5.0	3.9	4.8	4.1	4.6	4.4		
28.0																		3.2	3.9	4.4	3.2	4.1	4.4	3.3	4.2	3.5	4.0	3.8	3.8		
30.0																		2.7	3.4	3.9	2.7	3.6	3.8	2.8	3.6	3.0	3.5	3.2	3.2		
32.0																			2.3	3.1	3.4	2.4	3.2	2.5	3.0	2.8	2.8	2.8			
34.0																				1.8	2.7	3.0	1.9	2.8	2.1	2.6	2.4	2.4			
36.0																									1.5	2.4	1.8	2.0	2.0		
38.0																									1.2	2.1	1.4	2.0	1.7	1.7	
40.0																										1.1	1.7	1.4	1.4		
42.0																										0.8	1.4	1.1	1.1		
44.0																													0.8	0.8	
46.0																														0.6	
ピン無最大荷重	21.5	21.8	23.0	17.6	21.4	27.6	15.4	17.7	20.1	21.3	22.3	17.8	20.3	16.3	18.0	18.8	20.3	17.3	18.4	16.1	18.3	16.1	14.8	15.8	12.9	12.9	11.0	10.2	8.9		
θ(°)	0~82	0~82		0~82				0~82				0~82			0~82			0~82			0~82			0~82		0~82		0~82	0~82		
伸長状態(伸長割合)																															
伸縮ブーム1	0	46	0	92	46	0	0	92	46	0	0	92	0	0	92	46	0	92	46	0	92	46	0	92	0	92	46	92	100		
伸縮ブーム2	0	0	0	0	46	0	0	46	46	0	0	46	46	0	46	46	0	46	46	0	46	46	0	46	46	92	92	92	92	100	
伸縮ブーム3	0	0	0	0	0	0	0	0	46	46	0	46	46	0	46	46	46	46	46	46	92	46	46	92	92	92	92	92	92	100	
伸縮ブーム4	0	0	0	0	0	46	0	0	46	46	0	46	46	46	92	46	46	46	46	92	46	92	46	92	46	92	92	92	92	100	
伸縮ブーム5	0	0	46	0	0	46	92	0	0	46	92	0	46	92	0	46	92	46	92	46	92	46	92	46	92	46	92	92	92	100	
標準フック	55t	55t		55t				55t				55t			55t			55t			55t		18t		18t		18t		18t	18t	
フック重量	650kg	650kg		650kg				650kg				650kg			650kg			650kg			650kg		300kg		300kg		300kg		300kg	300kg	
主巻時標準巻掛本数	11	11	7	11	10	7	6	9	7	6	8	7	5	6	5	5	5	4	4	3	3	3	3	3	3	2	2	2	2		
補巻時標準巻掛本数	11	11	7		9	7	6	8	7	6		6	5	6	5	5	4	4	3					3	3	2	2	2	2		
補巻時最大荷重	54.6	54.6	35.0		45.6	35.0	29.9	40.9	35.0	29.3		31.3	25.3	31.3	28.5	22.0	23.8	20.9	17.3	19.7	16.1	14.8	15.8	12.9	12.9	11.0	10.2	8.9			

注)カウンタウエイト 25t、アウトリガ張出幅 5.0m

【N性能】

ブーム

単位:t

性能ブロック	1	9	1	9	10	2	1	10	11	2	1	11	2	1	12	2	1	2	3	1	5	4	1	6	1	7	1	1	8		
性能番号	1	23	2	24	25	12	3	26	27	13	4	28	14	5	29	15	6	16	17	7	19	18	8	20	9	21	10	11	22		
ブーム長さ(m)	11.1	14.8			18.5			22.1				25.8			29.5			33.2			36.9			40.5			44.2			47.9	51.2
作業半径(m)	2.5	54.6																													
3.0	54.6	54.6	35.0	54.6	50.0	35.0	29.9																								
3.5	54.6	54.6	35.0	54.6	50.0	35.0	27.8	45.6	45.6	35.0	29.3																				
4.0	54.6	54.6	35.0	53.9	50.0	35.0	26.0	45.6	45.6	35.0	27.6	40.9	34.2	25.3																	
4.5	54.6	54.6	33.7	49.8	50.0	35.0	24.4	45.6	45.6	35.0	26.1	40.9	34.2	24.2																	
5.0	50.5	50.1	32.0	46.3	50.0	34.8	22.9	42.7	45.6	35.0	24.7	38.8	34.2	23.1	31.3	28.5	22.0														
6.0	42.3	41.8	29.1	40.4	41.9	32.0	20.6	37.2	41.9	33.7	22.4	34.6	34.2	21.2	31.1	28.5	21.1	23.8	20.9	17.3											
7.0	32.6	31.8	26.8	31.3	32.1	29.6	18.6	31.6	32.5	31.5	20.5	31.1	32.7	19.2	28.7	28.5	19.7	23.8	20.9	17.3	19.7	16.1	14.8	15.8	12.9						
8.0	25.8	25.2	24.8	24.6	25.3	27.6	17.0	24.9	25.8	27.7	18.9	25.3	27.4	17.2	26.0	27.0	18.3	23.8	20.9	16.2	19.7	16.1	14.8	15.8	12.9	12.9	11.0				
9.0	21.2	20.5	22.3	20.0	20.7	22.8	15.7	20.3	21.1	22.9	17.5	20.7	22.7	15.6	21.3	22.3	17.0	21.9	20.6	15.1	19.7	16.1	14.8	15.8	12.9	12.9	11.0	10.2			
10.0	17.1	18.8	16.7	17.3	19.3	14.5	16.9	17																							

【O性能】

ブーム

単位:t

性能ブロック 性能番号	1	9	1	9	10	2	1	10	11	2	1	11	2	1	12	2	1	2	3	1	5	4	1	6	1	7	1	1	8							
ブーム長さ(m) 作業半径(m)	11.1	14.8			18.5			22.1			25.8			29.5			33.2			36.9			40.5			44.2		47.9		51.2						
2.5	54.6																																			
3.0	54.6	54.6	35.0	54.6	50.0	35.0	29.9																													
3.5	54.6	54.6	35.0	54.6	50.0	35.0	27.8	45.6	45.6	35.0	29.3																									
4.0	54.6	54.6	35.0	53.9	50.0	35.0	26.0	45.6	45.6	35.0	27.6	40.9	34.2	25.3																						
4.5	53.6	53.1	33.7	49.8	50.0	35.0	24.4	45.6	45.6	35.0	26.1	40.9	34.2	24.2																						
5.0	48.5	48.0	32.0	46.3	48.2	34.8	22.9	42.7	45.6	35.0	24.7	38.8	34.2	23.1	31.3	28.5	22.0																			
6.0	36.1	35.4	29.1	34.7	35.6	32.0	20.6	35.0	36.1	33.7	22.4	34.6	34.2	21.2	31.1	28.5	21.1	23.8	20.9	17.3																
7.0	27.1	26.4	26.8	25.8	26.6	29.1	18.6	26.1	27.1	29.1	20.5	26.6	26.9	19.2	27.3	28.4	19.7	23.8	20.9	17.3	19.7	16.1	14.8	15.8	12.9											
8.0	21.4	20.7	22.6	20.2	20.9	23.1	17.0	20.4	21.3	23.2	18.9	20.9	23.0	17.2	21.5	22.6	18.3	22.1	20.9	16.2	19.7	16.1	14.8	15.8	12.9	12.9	11.0									
9.0	17.4	16.7	18.5	16.2	16.9	19.0	15.7	16.5	17.3	19.1	17.5	16.9	18.9	15.6	17.5	18.5	17.0	18.1	19.0	15.1	18.1	16.1	14.8	15.8	12.9	12.9	11.0	10.2								
10.0		13.9	15.5	13.4	14.0	16.0	14.5	13.6	14.4	16.1	16.3	14.0	15.9	14.3	14.6	15.5	15.5	15.1	16.0	14.1	15.1	16.1	14.1	15.3	12.9	12.9	11.0	10.2	8.9							
11.0		11.7	13.3	11.2	11.8	13.8	13.4	11.4	12.2	13.8	14.3	11.8	13.6	13.2	12.3	13.3	14.2	12.9	13.7	13.2	12.9	14.0	13.3	13.0	12.9	12.9	11.0	10.2	8.9							
12.0		9.9	11.5	9.5	10.1	11.9	12.0	9.7	10.4	12.0	12.5	10.1	11.8	12.2	10.6	11.5	12.6	11.1	11.9	12.1	11.1	12.2	12.5	11.3	12.2	11.5	11.0	10.2	8.9							
14.0				6.9	7.5	9.3	9.3	7.1	7.8	9.3	9.8	7.5	9.1	9.8	8.0	8.8	9.9	8.4	9.2	9.8	8.4	9.5	9.8	8.6	9.5	8.8	9.4	9.1	8.9							
16.0				5.2	5.7	7.4	7.5	5.3	6.0	7.5	7.9	5.7	7.3	7.9	6.1	6.9	8.0	6.6	7.4	7.9	6.6	7.6	7.9	6.7	7.7	6.9	7.5	7.2	7.2							
18.0								4.0	4.7	6.1	6.5	4.3	5.9	6.5	4.8	5.6	6.6	5.2	6.0	6.5	5.2	6.2	6.5	5.4	6.2	5.5	6.1	5.8	5.8							
20.0								3.0	3.7	5.1	5.5	3.3	4.8	5.5	3.7	4.5	5.5	4.2	4.9	5.4	4.2	5.1	5.4	4.3	5.2	4.5	5.0	4.8	4.8							
22.0												2.5	4.0	4.6	2.2	3.0	4.0	2.6	3.4	3.9	2.6	3.5	3.8	2.8	3.6	2.9	3.4	3.2	3.2							
24.0															1.7	2.5	3.4	2.1	2.8	3.3	2.1	3.0	3.2	2.2	3.0	2.4	2.9	2.6	2.6							
26.0																					1.6	2.3	2.8	1.6	2.5	2.8	1.7	2.5	1.9	2.4	2.2	2.1				
28.0																																				
30.0																					1.2	1.9	2.4	1.1	2.1	2.3	1.3	2.1	1.5	2.0	1.7	1.7				
32.0																																				
34.0																																				
36.0																																				
38.0																																				
40.0																																				
ピン無 最大荷重	21.5	21.8	23.0	17.6	21.4	27.6	15.4	17.7	20.1	21.3	22.3	17.8	20.3	16.3	18.0	18.8	20.3	17.3	18.4	16.1	18.3	16.1	14.8	15.8	12.9	12.9	11.0	10.2	8.9							
θ(°)	0~82	0~82		0~82			0~82			0~82			0~82			0~82			0~82			0~82			20~82		0~82		28~82		12~82		34~82		42~82	
伸長状態(伸長割合%)																																				
伸縮ブーム1	0	46	0	92	46	0	0	92	46	0	0	92	0	0	92	46	0	92	46	0	92	46	0	92	46	0	92	46	92	100						
伸縮ブーム2	0	0	0	0	46	0	0	46	46	0	0	46	46	0	46	46	0	46	46	0	46	46	0	46	46	0	46	46	92	92	100					
伸縮ブーム3	0	0	0	0	0	0	0	0	46	46	0	46	46	0	46	46	0	46	46	0	46	46	0	46	46	0	46	46	92	92	92	100				
伸縮ブーム4	0	0	0	0	0	46	0	0	46	46	0	46	46	0	46	46	0	46	46	0	46	46	0	46	46	0	46	46	92	92	92	100				
伸縮ブーム5	0	0	46	0	0	46	92	0	0	46	92	0	46	92	0	46	92	0	46	92	0	46	92	0	46	92	0	46	92	92	100					
標準フック フック重量	55t	55t	55t	55t	55t	55t	55t	55t	55t	55t	55t	55t	55t	55t	55t	55t	55t	55t	55t	55t	55t	55t	55t	55t	55t	55t	55t	55t	55t	55t	55t	55t	55t	18t	18t	
主巻時標準 巻掛本数	11	11	7	11	10	7	6	9	7	6	8	7	5	6	5	5	5	5	5	4	4	3	3	3	3	3	2	2	2	2	2	2	2	2		
補巻時標準 巻掛本数	11	11	7		9	7	6	8	7	6		6	5	6	5	5	5	5	4	4	3		3		3		3	2	2	2	2	2	2	2		
補巻時 最大荷重	54.6	54.6	35.0		45.6	35.0	29.9		40.9	35.0	29.3		31.3	25.3		31.3	28.5	22.0		23.8	20.9	17.3		19.7	16.1	14.8	15.8	12.9	12.9	11.0	10.2	8.9				

注)カウンタウエイト 15t、アウトリガ張出幅 5.0m

【P性能】

ブーム

単位:t

性能ブロック 性能番号	1	9	1	9	10	2	1	10	11	2	1	11	2	1	12	2	1	2	3	1	5	4	1	6	1	7	1	1	1	2				
ブーム長さ(m) 作業半径(m)	11.1	14.8			18.5			22.1			25.8			29.5			33.2			36.9			40.5			44.2		47.9		51.2				
2.5	54.6																																	
3.0	54.6	54.6	35.0	54.6	50.0	35.0	29.9																											
3.5	54.6	54.6	35.0	54.6	50.0	35.0	27.8	45.6	45.6	35.0	29.3																							
4.0	54.6	54.6	35.0	53.9	50.0	35.0	26.0	45.6	45.6	35.0	27.6	40.9	34.2	25.3																				
4.5	51.3	50.8	33.7	49.8	50.0	35.0	24.4	45.6	45.6	35.0	26.1	40.9	34.2	24.2																				
5.0	42.4	41.5	32.0	40.7	41.8	34.8	22.9	41.1	42.4	35.0	24.7	38.8	34.2	23.1	31.3	28.5	22.0																	
6.0	29.0	28.2	29.1	27.6	28.4	31.2	20.6	27.9	29.0	31.3	22.4	28.4	31.0	21.2	29.2	28.5	21.1	23.8	20.9	17.3														
7.0	21.5	20.8	22.9	20.3	21.0	23.5	18.6	20.6	21.5	23.6	20.5	21.0	23.3	19.2	21.7	22.9	19.7	22.4	20.9	17.3	19.7	16.1	14.8	15.8	12.9									
8.0	16.8	16.1	18.0	15.6	16.3	18.6	17.0	15.9	16.8	18.7	18.9	16.3	18.4	17.2	17.0	18.0	18.3	17.6	18.6	16.2	17.6	16.1	14.8	15.8	12.9	12.9	11.0							
9.0	13.6	12.9	14.6	12.4	13.1	15.2	15.3	12.7	13.5	15.3	15.8	13.1	15.0	15.6	13.7	14.7	16.0	14.2	15.2	15.1	14.2	15.5	14.8	14.4	12.9	12.9	11.0	10.2						
10.0		10.5	12.2	10.0	10.7	12.7	12.8	10.3	11.1	12.8	13.3	10.7	12.6	13.3	11.2	12.2	13.4	11.8	12.7	13.3	11.8	12.9	13.3	12.0	12.9	12.2	11.0	10.2	8.9					
11.0		8.7	10.3	8.2	8.9	10.8	10.9	8.5	9.2	10.9	11.3	8.9	10.7	11.4	9.4	10.3	11.5	9.9	10.8	11.4	9.9	11.0	11.4	10.1	11.1	10.3	10.9	10.2	8.9					
12.0		7.3	8.8	6.8	7.4	9.3	9.4	7.0	7.8	9.4	9.8	7.4	9.2	9.9	7.9	8.8	10.0	8.4	9.3	9.9	8.4	9.5	9.9	8.6	9.6									

ブーム

【Q性能】

ブーム

単位:t

性能フロック	1	9	1	9	10	2	1	10	11	2	1	11	2	1	12	2	1	2	3	1	5	4	1	6	1	7	1	1	8							
性能番号	1	23	2	24	25	12	3	26	27	13	4	28	14	5	29	15	6	16	17	7	19	18	8	20	9	21	10	11	22							
ブーム長さ(m)	11.1	14.8			18.5			22.1					25.8			29.5			33.2			36.9			40.5			44.2			47.9	51.2				
作業半径(m)	2.5	54.6			54.6			54.6			54.6			45.6			45.6			40.9			40.9			33.2			33.2			29.5			29.5	25.8
3.0	54.6	54.6	35.0	54.6	50.0	35.0	29.9																													
3.5	54.6	54.6	35.0	54.6	50.0	35.0	27.8	45.6	45.6	35.0	29.3																									
4.0	54.6	54.6	35.0	53.9	50.0	35.0	26.0	45.6	45.6	35.0	27.6	40.9	34.2	25.3																						
4.5	45.4	44.4	33.7	43.5	44.8	35.0	24.4	44.0	45.5	35.0	26.1	40.9	34.2	24.2																						
5.0	35.4	34.5	32.0	33.8	34.8	34.8	22.9	34.2	35.5	35.0	24.7	34.8	34.2	23.1	31.3	28.5	22.0																			
6.0	24.0	23.2	25.5	22.6	23.5	26.2	20.6	22.9	24.0	26.3	22.4	23.5	26.0	21.2	24.3	25.6	21.1	23.8	20.9	17.3																
7.0	17.7	17.0	19.0	16.4	17.2	19.6	18.6	16.7	17.7	19.7	20.3	17.2	19.5	19.2	17.9	19.0	19.7	18.5	19.6	17.3	18.6	16.1	14.8	15.8	12.9											
8.0	13.7	13.0	14.9	12.5	13.2	15.4	15.5	12.7	13.6	15.5	16.1	13.2	15.3	16.1	13.8	14.9	16.3	14.4	15.4	16.1	14.4	15.7	14.8	14.6	12.9	12.9	11.0									
9.0	10.9	10.2	12.0	9.7	10.4	12.5	12.6	10.0	10.8	12.6	13.1	10.4	12.4	13.2	11.0	12.0	13.3	11.6	12.5	13.2	11.6	12.8	13.2	11.8	12.9	12.0	11.0	10.2								
10.0		8.2	9.9	7.7	8.4	10.4	10.4	8.0	8.8	10.5	11.0	8.4	10.2	11.0	8.9	9.9	11.1	9.5	10.4	11.0	9.5	10.6	11.0	9.7	10.7	9.9	10.5	10.2	8.9							
11.0		6.7	8.3	6.2	6.8	8.8	8.8	6.4	7.2	8.8	9.3	6.8	8.6	9.4	7.4	8.3	9.5	7.9	8.7	9.4	7.9	9.0	9.3	8.1	9.1	8.3	8.9	8.6	8.6							
12.0		5.5	7.0	5.0	5.6	7.5	7.5	5.2	6.0	7.5	8.0	5.6	7.3	8.1	6.1	7.0	8.2	6.6	7.5	8.1	6.6	7.7	8.0	6.8	7.8	7.0	7.6	7.3	7.3							
14.0				3.2	3.8	5.6	5.6	3.4	4.2	5.6	6.1	3.8	5.5	6.1	4.3	5.1	6.2	4.8	5.6	6.1	4.8	5.8	6.1	4.9	5.9	5.1	5.7	5.4	5.4							
16.0				2.0	2.6	4.3	4.3	2.2	2.9	4.3	4.7	2.5	4.1	4.8	3.0	3.8	4.9	3.5	4.2	4.8	3.4	4.4	4.7	3.6	4.5	3.8	4.3	4.1	4.1							
18.0								1.3	2.0	3.4	3.8	1.6	3.2	3.8	2.0	2.8	3.9	2.5	3.2	3.8	2.5	3.4	3.7	2.6	3.5	2.8	3.3	3.1	3.1							
20.0									1.3	2.6	3.0	0.9	2.4	3.0	1.3	2.1	3.1	1.7	2.5	3.0	1.7	2.7	3.0	1.9	2.7	2.1	2.6	2.3	2.3							
22.0																		1.5	2.5	1.2	1.9	2.4	1.1	2.1	2.3	1.3	2.1	1.7	1.7							
24.0																		1.0	2.0	1.4	1.9	1.6	1.9	1.6	1.9	1.6	1.5	2.0	1.7	1.7						
26.0																			1.0	1.5	1.2	1.4	1.2	1.4	1.2	1.1	1.2	1.1	1.1							
28.0																				1.0	1.2	0.8	1.1	0.9	1.1	0.9	0.7	0.7	0.7							
30.0																					0.9	0.5	0.8	0.6	0.6	0.6	0.6	0.6	0.6							
32.0																																				
ピン無最大荷重	21.5	21.8	23.0	17.6	21.4	27.6	15.4	17.7	20.1	21.3	22.3	17.8	20.3	16.3	18.0	18.8	20.3	17.3	18.4	16.1	18.3	16.1	14.8	15.8	12.9	12.9	11.0	10.2	8.9							
θ(°)	0~82	0~82		0~82				0~82				27~82	0~82		39~82	0~82		43~82	0~82		53~82	20~82	0~82	55~82	38~82	58~82	50~82	60~82	62~82							
伸長状態(伸長割合%)																																				
伸縮ブーム1	0	46	0	92	46	0	0	92	46	0	0	92	0	0	92	46	0	92	46	0	92	46	0	92	0	92	46	92	100							
伸縮ブーム2	0	0	0	0	46	0	0	46	46	0	0	46	46	0	46	46	0	46	46	0	46	46	0	92	46	92	92	92	92	100						
伸縮ブーム3	0	0	0	0	0	0	0	0	46	46	0	46	46	0	46	46	46	46	46	46	92	46	92	92	92	92	92	92	92	100						
伸縮ブーム4	0	0	0	0	0	46	0	0	46	46	0	46	92	46	46	92	46	46	46	46	92	46	92	46	92	92	92	92	92	100						
伸縮ブーム5	0	0	46	0	0	46	92	0	0	46	92	0	46	92	0	46	92	46	92	46	92	46	92	46	92	46	92	46	92	100						
標準フック	55t	55t		55t				55t				55t			55t			55t			55t	55t	18t	18t	18t	18t	18t	18t	18t							
フック重量	650kg	650kg		650kg				650kg				650kg			650kg			650kg			650kg	650kg	300kg	300kg	300kg	300kg	300kg	300kg	300kg							
主巻時標準巻掛本数	11	11	7	11	10	7	6	9	7	6	8	7	5	6	5	5	4	4	4	3	3	3	3	3	2	2	2	2								
補巻時標準巻掛本数	11	11	7		9	7	6	8	7	6	6	6	5	6	5	5	4	4	3	3	3	3	3	2	2	2	2	2								
補巻時最大荷重	54.6	54.6	35.0		45.6	35.0	29.9	40.9	35.0	29.3	31.3	25.3	31.3	28.5	22.0	23.8	20.9	17.3	18.6	16.1	14.8	15.8	12.9	12.9	11.0	10.2	8.9									

注)カウンタウエイト 5t、アウトリガ張出幅 5.0m

【R性能】

ブーム

単位:t

性能フロック	1	9	1	9	10	2	1	10	11	2	1	11	2	1	12	2	1	2	3	1	5	4	1	6	1	7	1	1	8				
性能番号	1	23	2	24	25	12	3	26	27	13	4	28	14	5	29	15	6	16	17	7	19	18	8	20	9	21	10	11	22				
ブーム長さ(m)	11.1	14.8			18.5			22.1					25.8			29.5			33.2			36.9			40.5			44.2			47.9	51.2	
作業半径(m)	2.5	54.6			54.6			54.6			45.6			45.6			40.9			40.9			33.2			33.2			29.5			29.5	25.8
3.0	54.6	54.6	35.0	54.6	50.0	35.0	29.9																										
3.5	54.6	54.6	35.0	54.6	50.0	35.0	27.8	45.6	45.6	35.0	29.3																						
4.0	44.0	42.8	35.0	41.8	43.2	35.0	26.0	42.3	44.1	35.0	27.6	40.9	34.2	25.3																			
4.5	31.8	30.8	33.7	30.0	31.2	34.9	24.4	30.5	31.9	35.0	26.1	31.2	34.2	24.2																			
5.0	24.6	23.7	26.4	22.9	24.0	27.2	22.9	23.3	24.6	27.4	24.7	24.0	27.0	23.1	24.9	26.5	22.0																
6.0	16.2	15.5	17.8	14.9	15.7	18.5	18.6	15.2	16.3	18.6	19.2	15.8	18.3	19.4	16.5	17.8	19.5	17.3	18.5	17.3													
7.0	11.6	10.9	12.9	10.4	11.1	13.6	13.7	10.7	11.6	13.7	14.3	11.2	13.4	14.4	11.8	13.0	14.5	12.5	13.6	14.4	12.5	13.9	14.3	12.7	12.9								
8.0	8.7	8.0	9.9	7.5	8.2	10.5	10.5	7.8	8.7	10.6	11.1	8.3	10.2	11.0	8.9	9.9	11.3	9.5	10.5	11.2	9.5	10.8	11.2	9.7	10.9	9.9	10.6						
9.0	6.7	6.0	7.8	5.6	6.2	8.3	8.4	5.8	6.6	8.4	8.9	6.2	8.2	9.0	6.8	7.8	9.1	7.4	8.3	9.0	7.4	8.6	9.0	7.6	8.7	7.8	8.5	8.2					
10.0		4.6	6.2	4.1	4.7	6.8	6.8	4.4	5.2	6.8	7.3	4.8	6.6	7.4	5.3	6.3	7.5	5.9	6.8	7.4	5.9	7.0	7.4	6.0	7.1	6.3	6.9	6.6	6.6				
11.0		3.5	5.1	3.0	3.6	5.6	5.6	3.2	4.0	5.6	6.1	3.6	5.4	6.2	4.2	5.1	6.3	4.7	5.5	6.2	4.7	5.8	6.1	4.9	5.9	5.1	5.7	5.4	5.4				
12.0		2.6	4.1	2.1	2.7	4.6	4.7	2.4	3.1	4.7	5.1	2.7	4.5	5.2	3.3	4.1	5.3	3.8	4.6	5.2	3.8	4.8	5.2	3.9	4.9	4.1	4.7	4.5	4.5				
14.0				0.9	1.4	3.2	3.3	1.1	1.8	3.3	3.7	1.4	3.1	3.8	1.9	2.8	3.9	2.4	3.2	3.8	2.4	3.4	3.7	2.6	3.5	2.8	3.3	3.1	3.1				
16.0						2.3	2.3		0.9	2.3	2.7	2.1	2.8		1.8	2.9	1.4	2.2	2.8		2.4	2.7	1.										

【S性能】

ブーム

単位:t

性能ブロック 性能番号	1	9	1	9	10	2	1	10	11	2	1
性能番号	1	23	2	24	25	12	3	26	27	13	4
ブーム長さ(m) 作業半径(m)	11.1	14.8		18.5			22.1				
2.5	54.6										
3.0	47.2	46.7	35.0	46.4	46.9	35.0	29.9				
3.5	41.6	41.2	35.0	40.8	41.3	35.0	27.8	41.0	41.6	35.0	29.3
4.0	37.3	36.9	35.0	36.6	37.0	35.0	26.0	36.8	37.3	35.0	27.6
4.5	33.9	33.5	33.7	33.2	33.6	35.0	24.4	33.3	33.9	35.0	26.1
5.0	31.0	30.6	31.8	30.3	30.8	32.2	22.9	30.5	31.1	32.3	24.7
6.0	26.5	26.1	27.3	25.8	26.2	27.7	20.6	26.0	26.5	27.7	22.4
7.0	23.0	22.6	23.8	22.3	22.7	24.2	18.6	22.5	23.0	24.2	20.5
8.0	18.3	17.6	19.6	17.0	17.8	20.3	17.0	17.3	18.3	20.4	18.9
9.0	14.6	13.8	15.7	13.3	14.0	16.3	15.7	13.6	14.5	16.4	17.0
10.0		11.2	12.9	10.7	11.3	13.5	13.6	10.9	11.8	13.6	14.1
11.0			9.2	10.8	8.7	9.3	11.4	8.9	9.7	11.5	12.0
12.0			7.6	9.2	7.1	7.8	9.7	9.8	7.4	8.2	9.8
14.0				4.9	5.5	7.4	7.4	5.1	5.9	7.4	7.9
16.0				3.4	3.9	5.7	5.8	3.6	4.3	5.8	6.2
18.0								2.4	3.1	4.6	5.0
20.0								1.6	2.3	3.7	4.1
ピン無 最大荷重	21.5	21.8	23.0	17.6	21.4	27.6	15.4	17.7	20.1	21.3	22.3
θ(°)	0~ 82	0~ 82		0~ 82			0~ 82				
伸長状態(伸長割合%)											
伸縮ブーム1	0	46	0	92	46	0	0	92	46	0	0
伸縮ブーム2	0	0	0	0	46	0	0	46	46	0	0
伸縮ブーム3	0	0	0	0	0	0	0	0	46	46	0
伸縮ブーム4	0	0	0	0	0	46	0	0	0	46	46
伸縮ブーム5	0	0	46	0	0	46	92	0	0	46	92
標準フック	55t	55t		55t			55t				
フック重量	650kg	650kg		650kg			650kg				
主巻時標準 巻掛本数	11	10	7	10		7	6	9		7	6
補巻時標準 巻掛本数	11	10	7	9		7	6	8		7	6
補巻時 最大荷重	54.6	46.7	35.0	45.6		35.0	29.9	40.9		35.0	29.3

注)カウンタウエイト 0t、アウトリガ張出幅 2.55m(前後のみ)

【T性能】

ブーム

単位:t

性能ブロック 性能番号	1	9	1	9	10	2	1	10	11	2	1
性能番号	1	23	2	24	25	12	3	26	27	13	4
ブーム長さ(m) 作業半径(m)	11.1	14.8		18.5			22.1				
2.5	29.0										
3.0	19.2	18.4	21.0	17.7	18.7	21.8	22.0				
3.5	13.9	13.1	15.4	12.5	13.4	16.1	16.2	12.9	13.9	16.3	16.9
4.0	10.5	9.8	11.9	9.2	10.0	12.5	12.6	9.5	10.5	12.6	13.3
4.5	8.1	7.5	9.4	7.0	7.7	10.0	10.1	7.3	8.2	10.1	10.7
5.0	6.4	5.8	7.7	5.3	6.0	8.2	8.3	5.6	6.5	8.3	8.9
6.0	4.1	3.5	5.2	3.1	3.7	5.7	5.8	3.3	4.1	5.8	6.3
7.0	2.6	2.0	3.6		2.2	4.1	4.2		2.6	4.2	4.7
8.0	1.5	1.0	2.5			3.0	3.1			3.1	3.5
9.0			1.7			2.2	2.2			2.2	2.7
10.0			1.1			1.5	1.6			1.6	2.0
11.0						1.0	1.1			1.1	1.5
12.0											1.1
ピン無 最大荷重	21.5	18.4	21.0	17.6	18.7	21.8	15.4	12.9	13.9	16.3	16.9
θ(°)	0~ 82	50~ 82	6~ 82	66~ 82	63~ 82	42~ 82	41~ 82	72~ 82	68~ 82	56~ 82	49~ 82
伸長状態(伸長割合%)											
伸縮ブーム1	0	46	0	92	46	0	0	92	46	0	0
伸縮ブーム2	0	0	0	0	46	0	0	46	46	0	0
伸縮ブーム3	0	0	0	0	0	0	0	0	46	46	0
伸縮ブーム4	0	0	0	0	0	46	0	0	0	46	46
伸縮ブーム5	0	0	46	0	0	46	92	0	0	46	92
標準フック	55t	55t		55t			18t		55t		
フック重量	650kg	650kg		650kg			300kg		650kg		
主巻時標準 巻掛本数	6	4		4		5		3		4	
補巻時標準 巻掛本数	6	4		4		5		3		4	
補巻時 最大荷重	29.0	18.4	21.0	17.7	18.7	21.8	22.0	12.9	13.9	16.3	16.9

注)カウンタウエイト 0t、アウトリガ張出幅 2.55m

油圧チルトジブ

ブーム+油圧チルトジブ(HLJ)作業半径-揚程図

11.1mブーム+油圧チルトジブ

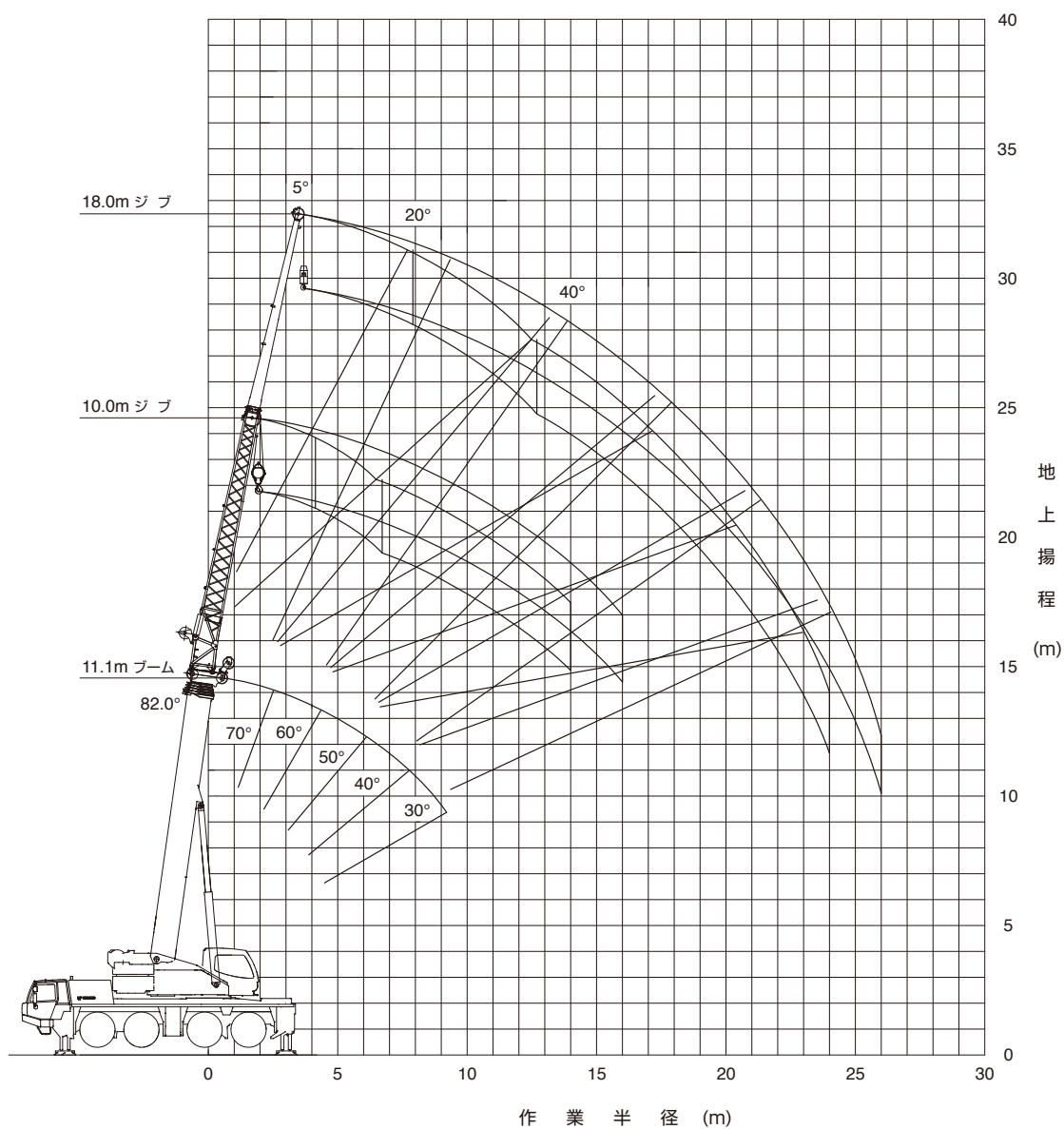

- (注) 1. 上図はブームおよびジブのたわみを含んでいません。
2. A性能を図示しています。

33.2mブーム+油圧チルトジブ

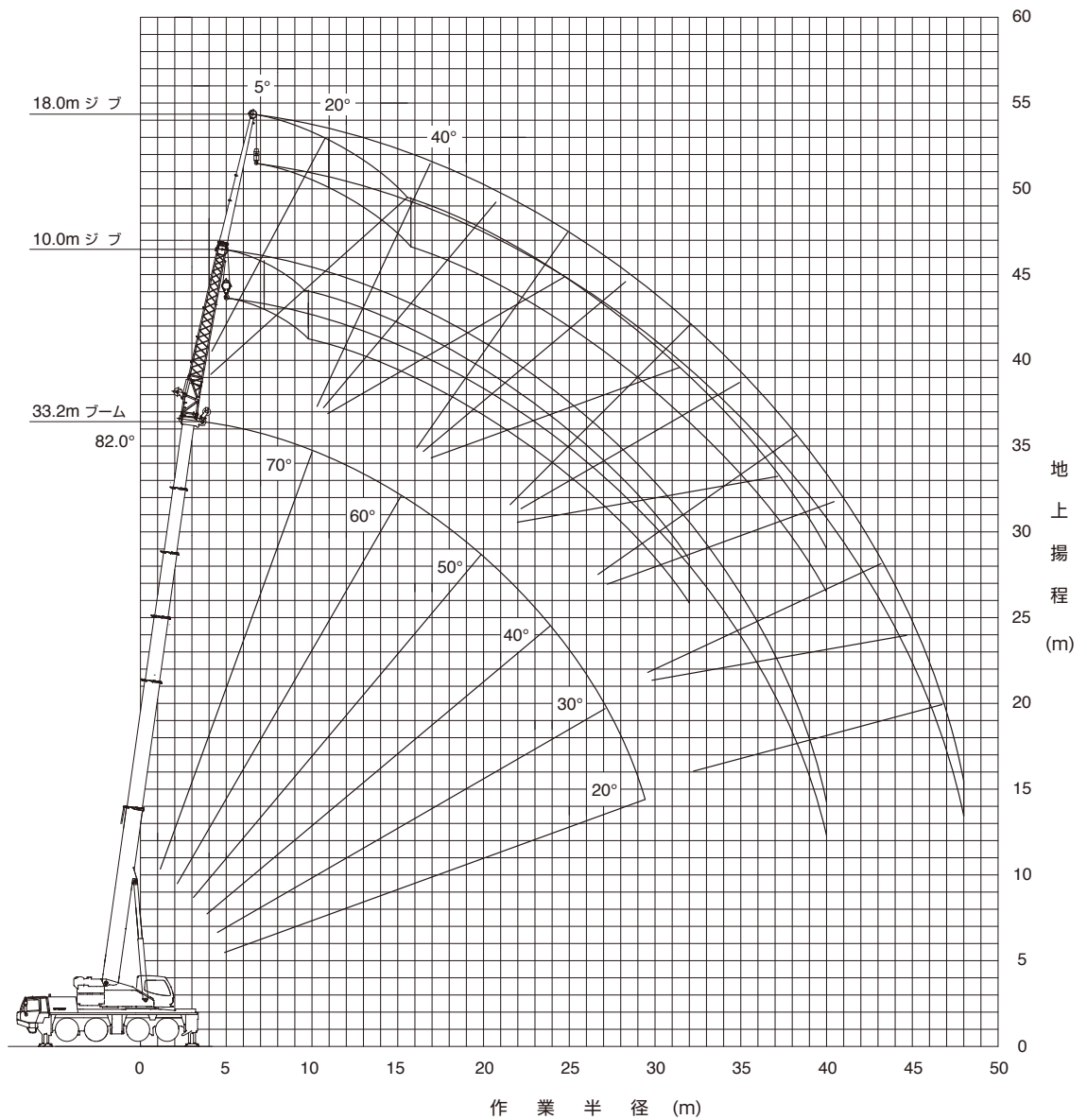

(注) 1. 上図はブームおよびジブのたわみを含んでいません。
 2. A性能を図示しています。

油圧チルトジブ

47.9mブーム+油圧チルトジブ

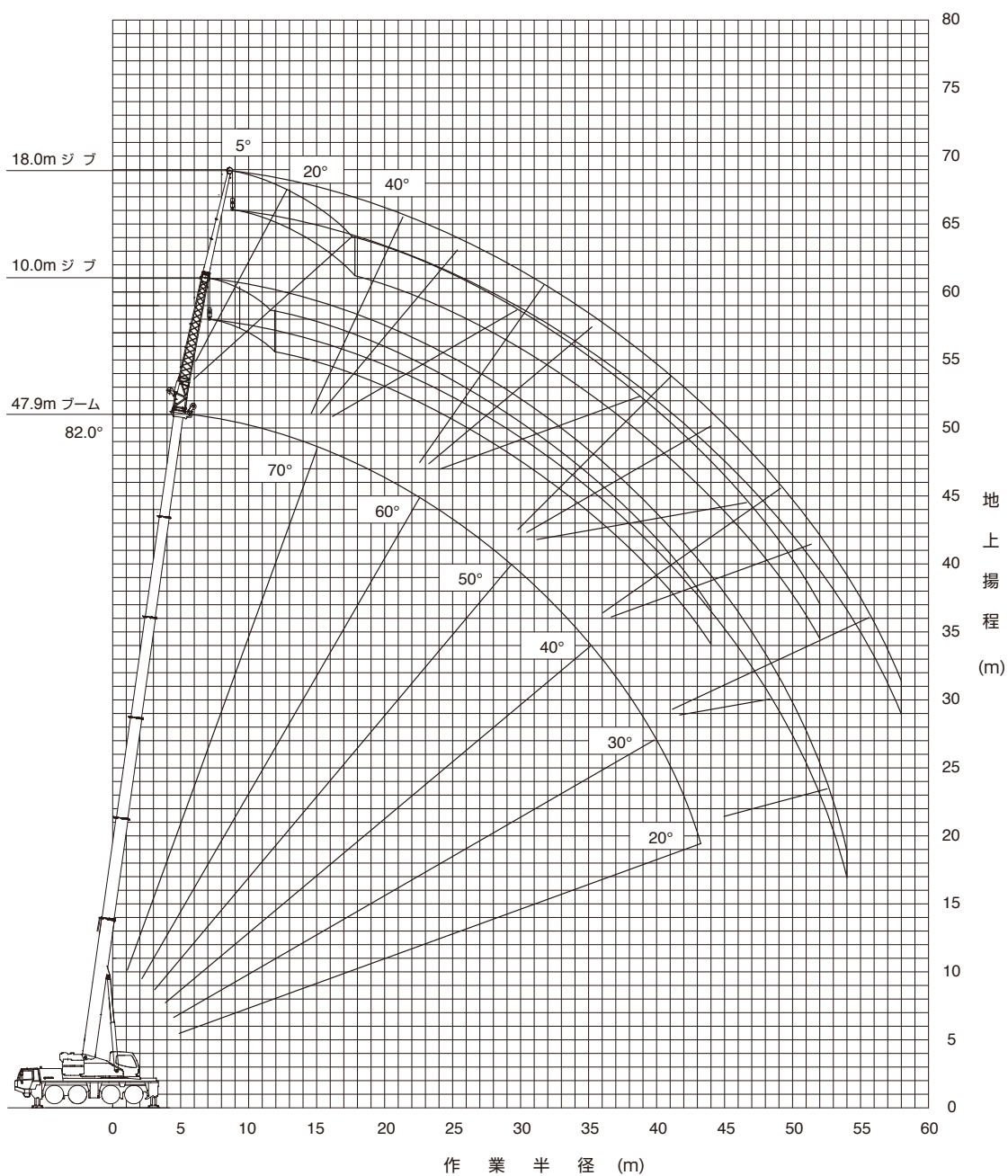

- (注) 1. 上図はブームおよびジブのたわみを含んでいません。
 2. A性能を図示しています。

51.2mブーム+油圧チルトジブ

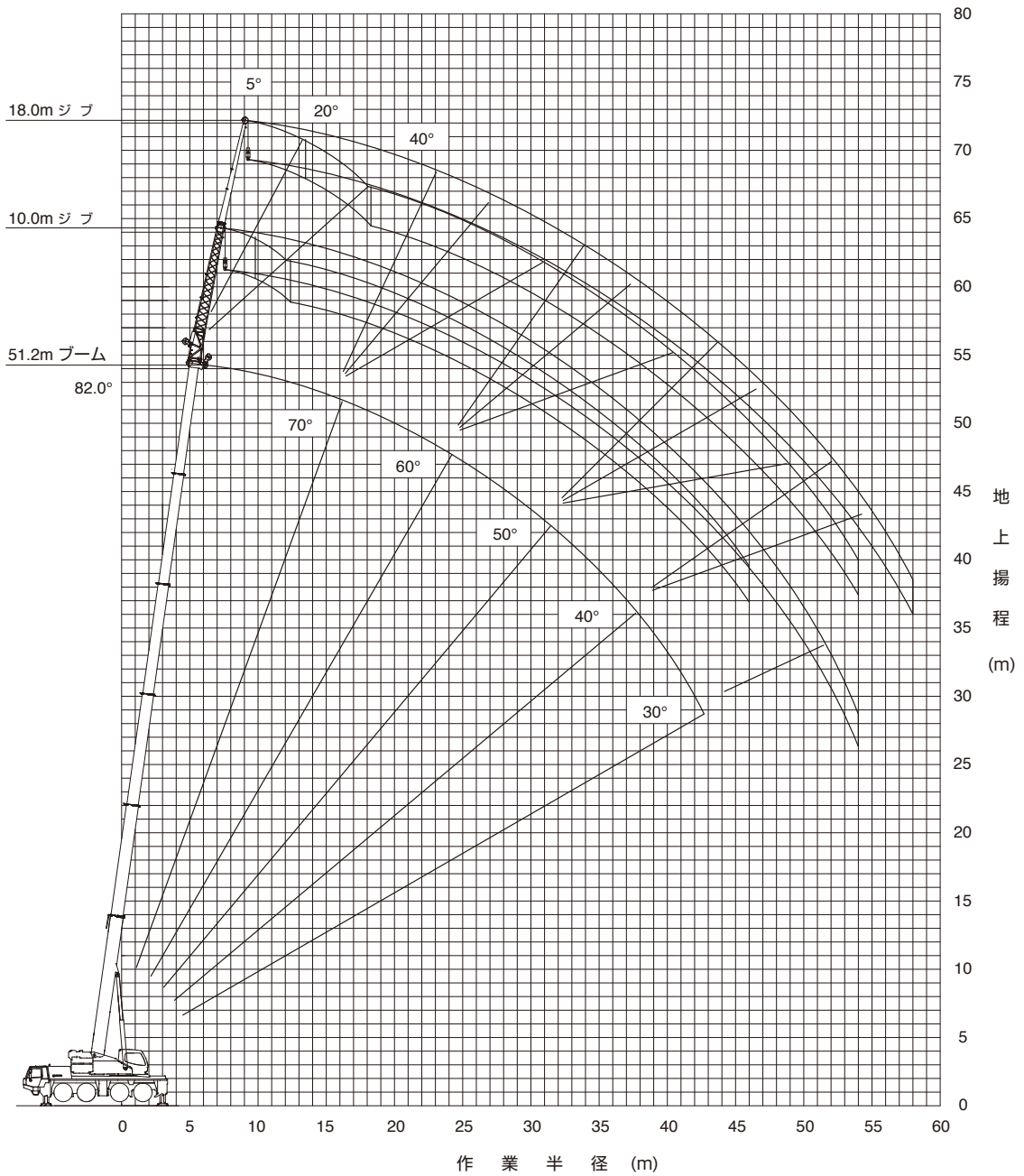

(注) 1. 上図はブームおよびジブのたわみを含んでいません。
 2. A性能を図示しています。

油圧チルトジブ

ブーム+油圧チルトジブ(HLJ)定格総荷重表

■ 定格総荷重表注意事項

◆定格総荷重表の性能区分A~Qは、下表のとおりです。

アウトリガ張出幅	カウンタウエイ	25 t	21 t	15 t	9 t	5 t
7.2 m		A	B	C	D	E
6.0 m		G	H	I	J	K
5.0 m		M	N	O	P	Q

◆定格総荷重は、つり具質量とフック質量(18tフック: 300kg、5.6tフック:150kg) を含んだ値を示します。

◆定格総荷重は、ブームとジブのたわみを含んだ実際の作業半径に基づいています。

◆各ブーム長さにおける各伸縮ブームの伸長状態(伸長割合%)は、下表のとおりです。

ブーム長さ	11.1 m	33.2 m	47.9 m	51.2 m
伸縮ブーム1	0	92	92	100
伸縮ブーム2	0	46	92	100
伸縮ブーム3	0	46	92	100
伸縮ブーム4	0	46	92	100
伸縮ブーム5	0	46	92	100

◆定格総荷重表中の標準巻掛本数よりも少ない本数で使用する場合、最大荷重の上限は下表のとおりです。

巻掛本数	1本
最大荷重	5.6t

◆定格総荷重は、アウトリガを水平堅土上に設置したときの値です。

◆定格総荷重表は、風による影響を含んでいません。瞬間最大風速が10m/s以上の風速では、クレーン作業を中止してください。

定格総荷重表中の線、および用語説明

◆太線より上側はクレーンの強度に、下側はクレーンの安定に基づいています。

◆「オフセット」はブームの中心線とジブの中心線とのなす角度を示します。

◆「 θ° 」は、無負荷状態で作動可能なブーム起伏角度範囲を示します。

【A性能】

11.1mブーム+油圧チルトジブ 単位:t

ジブ長さ(m) 作業半径 (m)	10.0			18.0		
	オフセット			オフセット		
	5°	20°	40°	5°	20°	40°
3.0	11.0					
3.5	11.0					
4.0	11.0					
4.5	11.0					
5.0	11.0	11.0		5.6		
6.0	11.0	10.2		5.6		
7.0	11.0	9.4		5.6		
8.0	11.0	8.7	6.9	5.6		
9.0	10.1	8.1	6.6	5.6		
10.0	9.3	7.6	6.3	5.6	5.0	
11.0	8.6	7.2	6.1	5.6	4.7	
12.0	8.0	6.8	5.9	5.4	4.4	
14.0	7.0	6.2	5.5	4.7	4.0	
16.0	6.2	5.7		4.1	3.6	3.1
18.0				3.7	3.3	2.9
20.0				3.3	3.0	2.7
22.0				3.1	2.8	2.6
24.0				2.8	2.7	2.5
26.0				2.6	2.5	
θ (°)	33~ 82	38~ 82	54~ 82	20~ 82	28~ 82	47~ 82
標準フック	18t			5.6t		
フック重量	300kg			150kg		
標準巻掛本数	2			1		

注)カウンタウエイト 25t、アウトリガ張出幅 7.2m

【A性能】

33.2mブーム+油圧チルトジブ 単位:t

ジブ長さ(m) 作業半径 (m)	10.0			18.0		
	オフセット			オフセット		
	5°	20°	40°	5°	20°	40°
8.0	10.1					
9.0	10.1					
10.0	10.1	8.9		4.2		
11.0	9.7	8.5		4.2		
12.0	9.3	8.1		4.2		
14.0	8.6	7.5	6.6	4.2		
16.0	8.0	7.0	6.2	4.2	4.2	
18.0	7.4	6.6	5.9	4.2	4.1	
20.0	6.9	6.2	5.6	4.2	3.9	3.2
22.0	6.5	5.9	5.4	4.2	3.8	3.0
24.0	6.1	5.6	5.1	4.2	3.6	2.9
26.0	5.8	5.3	5.0	4.0	3.5	2.9
28.0	5.4	5.1	4.8	3.9	3.4	2.8
30.0	4.7	4.9	4.6	3.7	3.2	2.7
32.0	4.1	4.3	4.4	3.6	3.1	2.6
34.0	3.6	3.7		3.5	3.0	2.6
36.0	3.1	3.2		3.3	2.9	2.5
38.0	2.7	2.8		3.1	2.8	2.5
40.0	2.4			2.9	2.7	2.5
42.0				2.5	2.6	
44.0				2.2	2.4	
46.0				2.0	2.1	
48.0				1.7		
θ (°)	15~ 82	27~ 82	46~ 82	18~ 82	29~ 82	47~ 82
標準フック	18t			5.6t		
フック重量	300kg			150kg		
標準巻掛本数	2			1		

注)カウンタウエイト 25t、アウトリガ張出幅 7.2m

【A性能】

47.9mブーム+油圧チルトジブ 単位:t

ジブ長さ(m) 作業半径 (m)	10.0			18.0		
	オフセット			オフセット		
	5°	20°	40°	5°	20°	40°
11.0	4.9					
12.0	4.9					
14.0	4.9			2.9		
16.0	4.9	4.9		2.9		
18.0	4.9	4.7	4.4	2.9		
20.0	4.8	4.4	4.2	2.9	2.9	
22.0	4.5	4.2	4.0	2.9	2.9	
24.0	4.3	4.0	3.8	2.9	2.9	
26.0	4.1	3.9	3.7	2.9	2.9	2.7
28.0	3.9	3.7	3.5	2.9	2.8	2.6
30.0	3.7	3.6	3.4	2.9	2.6	2.5
32.0	3.5	3.4	3.3	2.7	2.5	2.4
34.0	3.3	3.2	3.2	2.6	2.5	2.3
36.0	3.1	3.1	3.1	2.5	2.4	2.3
38.0	2.8	2.9	2.9	2.5	2.3	2.2
40.0	2.5	2.6	2.7	2.4	2.2	2.1
42.0	2.1	2.3	2.4	2.3	2.2	2.1
44.0	1.8	2.0	2.0	2.1	2.1	2.0
46.0	1.6	1.7		1.9	2.0	2.0
48.0	1.3	1.4		1.6	1.8	1.9
50.0	1.0	1.1		1.4	1.6	1.7
52.0	0.8	0.8		1.1	1.3	1.4
54.0	0.6			0.9	1.1	
56.0				0.7	0.8	
58.0				0.5	0.6	
θ (°)	20~ 82	28~ 82	46~ 82	31~ 82	34~ 82	47~ 82
標準フック	5.6t			5.6t		
フック重量	150kg			150kg		
標準巻掛本数	1			1		

注)カウンタウエイト 25t、アウトリガ張出幅 7.2m

【A性能】

51.2mブーム+油圧チルトジブ 単位:t

ジブ長さ(m) 作業半径 (m)	10.0			18.0		
	オフセット			オフセット		
	5°	20°	40°	5°	20°	40°
12.0	4.4					
14.0	4.4					
16.0	4.4	4.4		2.7		
18.0	4.4	4.4		2.7		
20.0	4.4	4.1	3.9	2.7		
22.0	4.2	4.0	3.7	2.7	2.7	
24.0	4.0	3.8	3.6	2.7	2.7	
26.0	3.8	3.6	3.5	2.7	2.7	2.6
28.0	3.6	3.5	3.3	2.7	2.6	2.5
30.0	3.4	3.3	3.2	2.7	2.5	2.4
32.0	3.2	3.1	3.1	2.6	2.4	2.3
34.0	3.0	3.0	3.0	2.5	2.3	2.2
36.0	2.8	2.9	2.8	2.4	2.2	2.1
38.0	2.6	2.7	2.7	2.3	2.2	2.1
40.0	2.4	2.4	2.5	2.2	2.1	2.0
42.0	2.1	2.2	2.3	2.1	2.0	1.9
44.0	1.8	1.9	2.0	2.0	2.0	1.9
46.0	1.5	1.6	1.7	1.8	1.9	1.8
48.0	1.2	1.3		1.5	1.7	1.8
50.0	1.0	1.1		1.3	1.5	1.6
52.0	0.7	0.8		1.1	1.3	1.4
54.0	0.5	0.6		0.8	1.0	1.2
56.0				0.6	0.8	
58.0					0.6	
θ (°)	29~ 82	30~ 82	47~ 82	41~ 82	40~ 82	49~ 82
標準フック	5.6t			5.6t		
フック重量	150kg			150kg		
標準巻掛本数	1			1		

注)カウンタウエイト 25t、アウトリガ張出幅 7.2m

油圧チルトジブ

【B性能】

11.1mブーム＋油圧チルトジブ

単位:t

ジブ長さ(m) 作業半径 (m)	10.0			18.0		
	オフセット			オフセット		
	5°	20°	40°	5°	20°	40°
3.0	11.0					
3.5	11.0					
4.0	11.0					
4.5	11.0					
5.0	11.0	11.0		5.6		
6.0	11.0	10.2		5.6		
7.0	11.0	9.4		5.6		
8.0	11.0	8.7	6.9	5.6		
9.0	10.1	8.1	6.6	5.6		
10.0	9.3	7.6	6.3	5.6	5.0	
11.0	8.6	7.2	6.1	5.6	4.7	
12.0	8.0	6.8	5.9	5.4	4.4	
14.0	7.0	6.2	5.5	4.7	4.0	
16.0	6.2	5.7		4.1	3.6	3.1
18.0				3.7	3.3	2.9
20.0				3.3	3.0	2.7
22.0				3.1	2.8	2.6
24.0				2.8	2.7	2.5
26.0				2.6	2.5	
θ (°)	33~ 82	38~ 82	54~ 82	20~ 82	28~ 82	47~ 82
標準フック	18t			5.6t		
フック重量	300kg			150kg		
標準巻掛本数	2			1		

注)カウンタウエイト 21t、アウトリガ張出幅 7.2m

【B性能】

33.2mブーム＋油圧チルトジブ

単位:t

ジブ長さ(m) 作業半径 (m)	10.0			18.0		
	オフセット			オフセット		
	5°	20°	40°	5°	20°	40°
8.0	10.1					
9.0	10.1					
10.0	10.1	8.9		4.2		
11.0	9.7	8.5		4.2		
12.0	9.3	8.1		4.2		
14.0	8.6	7.5	6.6	4.2		
16.0	8.0	7.0	6.2	4.2	4.2	
18.0	7.4	6.6	5.9	4.2	4.1	
20.0	6.9	6.2	5.6	4.2	3.9	3.2
22.0	6.5	5.9	5.4	4.2	3.8	3.0
24.0	6.1	5.6	5.1	4.2	3.6	2.9
26.0	5.4	5.3	5.0	4.0	3.5	2.9
28.0	4.7	4.9	4.8	3.9	3.4	2.8
30.0	4.0	4.2	4.4	3.7	3.2	2.7
32.0	3.5	3.6	3.8	3.6	3.1	2.6
34.0	3.0	3.1		3.5	3.0	2.6
36.0	2.5	2.6		3.1	2.9	2.5
38.0	2.2	2.2		2.7	2.8	2.5
40.0	1.8			2.4	2.6	2.5
42.0				2.0	2.2	
44.0				1.8	1.9	
46.0				1.5	1.6	
48.0				1.3		
θ (°)	15~ 82	27~ 82	46~ 82	18~ 82	29~ 82	47~ 82
標準フック	18t			5.6t		
フック重量	300kg			150kg		
標準巻掛本数	2			1		

注)カウンタウエイト 21t、アウトリガ張出幅 7.2m

【B性能】

47.9mブーム＋油圧チルトジブ

単位:t

ジブ長さ(m) 作業半径 (m)	10.0			18.0		
	オフセット			オフセット		
	5°	20°	40°	5°	20°	40°
11.0	4.9					
12.0	4.9					
14.0	4.9			2.9		
16.0	4.9	4.9		2.9		
18.0	4.9	4.7	4.4	2.9		
20.0	4.8	4.4	4.2	2.9	2.9	
22.0	4.5	4.2	4.0	2.9	2.9	
24.0	4.3	4.0	3.8	2.9	2.9	
26.0	4.1	3.9	3.7	2.9	2.9	2.7
28.0	3.9	3.7	3.5	2.9	2.8	2.6
30.0	3.7	3.6	3.4	2.9	2.6	2.5
32.0	3.5	3.4	3.3	2.7	2.5	2.4
34.0	3.1	3.2	3.2	2.6	2.5	2.3
36.0	2.7	2.8	3.0	2.5	2.4	2.3
38.0	2.3	2.4	2.6	2.5	2.3	2.2
40.0	1.9	2.1	2.2	2.3	2.2	2.1
42.0	1.6	1.8	1.9	1.9	2.2	2.1
44.0	1.4	1.5	1.6	1.7	1.9	2.0
46.0	1.1	1.2		1.4	1.6	1.8
48.0	0.8	0.9		1.2	1.4	1.5
50.0	0.6	0.7		1.0	1.1	1.3
52.0				0.7	0.9	1.0
54.0				0.5	0.7	
56.0					0.5	
θ (°)	31~ 82	33~ 82	46~ 82	39~ 82	38~ 82	47~ 82
標準フック	5.6t			5.6t		
フック重量	150kg			150kg		
標準巻掛本数	1			1		

注)カウンタウエイト 21t、アウトリガ張出幅 7.2m

【B性能】

51.2mブーム＋油圧チルトジブ

単位:t

ジブ長さ(m) 作業半径 (m)	10.0			18.0		
	オフセット			オフセット		
	5°	20°	40°	5°	20°	40°
12.0	4.4					
14.0	4.4					
16.0	4.4	4.4		2.7		
18.0	4.4	4.4		2.7		
20.0	4.4	4.1	3.9	2.7		
22.0	4.2	4.0	3.7	2.7	2.7	
24.0	4.0	3.8	3.6	2.7	2.7	
26.0	3.8	3.6	3.5	2.7	2.7	2.6
28.0	3.6	3.5	3.3	2.7	2.6	2.5
30.0	3.4	3.3	3.2	2.7	2.5	2.4
32.0	3.2	3.1	3.1	2.6	2.4	2.3
34.0	3.0	3.0	3.0	2.5	2.3	2.2
36.0	2.6	2.8	2.8	2.4	2.2	2.1
38.0	2.2	2.4	2.6	2.3	2.2	2.1
40.0	1.9	2.0	2.2	2.2	2.1	2.0
42.0	1.6	1.7	1.8	1.9	2.0	1.9
44.0	1.3	1.4	1.5	1.6	1.8	1.9
46.0	1.0	1.2	1.3	1.3	1.6	1.8
48.0	0.8	0.9		1.1	1.3	1.5
50.0	0.5	0.6		0.9	1.1	1.2
52.0				0.6	0.9	1.0
54.0					0.6	0.8
θ (°)	37~ 82	38~ 82	47~ 82	46~ 82	46~ 82	48~ 82
標準フック	5.6t			5.6t		
フック重量	150kg			150kg		
標準巻掛本数	1			1		

注)カウンタウエイト 21t、アウトリガ張出幅 7.2m

【C性能】

11.1mブーム+油圧チルトジブ 単位:t

ジブ長さ(m) 作業半径 (m)	10.0			18.0		
	オフセット			オフセット		
	5°	20°	40°	5°	20°	40°
3.0	11.0					
3.5	11.0					
4.0	11.0					
4.5	11.0					
5.0	11.0	11.0		5.6		
6.0	11.0	10.2		5.6		
7.0	11.0	9.4		5.6		
8.0	11.0	8.7	6.9	5.6		
9.0	10.1	8.1	6.6	5.6		
10.0	9.3	7.6	6.3	5.6	5.0	
11.0	8.6	7.2	6.1	5.6	4.7	
12.0	8.0	6.8	5.9	5.4	4.4	
14.0	7.0	6.2	5.5	4.7	4.0	
16.0	6.2	5.7		4.1	3.6	3.1
18.0				3.7	3.3	2.9
20.0				3.3	3.0	2.7
22.0				3.1	2.8	2.6
24.0				2.8	2.7	2.5
26.0				2.6	2.5	
θ (°)	33~ 82	38~ 82	54~ 82	20~ 82	28~ 82	47~ 82
標準フック	18t			5.6t		
フック重量	300kg			150kg		
標準巻掛本数	2			1		

注)カウンタウエイト 15t、アウトリガ張出幅 7.2m

【C性能】

33.2mブーム+油圧チルトジブ 単位:t

ジブ長さ(m) 作業半径 (m)	10.0			18.0		
	オフセット			オフセット		
	5°	20°	40°	5°	20°	40°
8.0	10.1					
9.0	10.1					
10.0	10.1	8.9		4.2		
11.0	9.7	8.5		4.2		
12.0	9.3	8.1		4.2		
14.0	8.6	7.5	6.6	4.2		
16.0	8.0	7.0	6.2	4.2	4.2	
18.0	7.4	6.6	5.9	4.2	4.1	
20.0	6.9	6.2	5.6	4.2	3.9	3.2
22.0	5.9	5.9	5.4	4.2	3.8	3.0
24.0	5.0	5.3	5.1	4.2	3.6	2.9
26.0	4.2	4.4	4.7	4.0	3.5	2.9
28.0	3.5	3.7	3.9	3.9	3.4	2.8
30.0	2.9	3.1	3.3	3.5	3.2	2.7
32.0	2.4	2.6	2.7	3.0	3.1	2.6
34.0	2.0	2.2		2.6	2.9	2.6
36.0	1.7	1.8		2.2	2.5	2.5
38.0	1.3	1.4		1.9	2.1	2.3
40.0	1.1			1.6	1.8	1.9
42.0				1.3	1.5	
44.0				1.0	1.2	
46.0				0.8	0.9	
48.0				0.6		
θ (°)	15~ 82	27~ 82	46~ 82	18~ 82	29~ 82	47~ 82
標準フック	18t			5.6t		
フック重量	300kg			150kg		
標準巻掛本数	2			1		

注)カウンタウエイト 15t、アウトリガ張出幅 7.2m

【C性能】

47.9mブーム+油圧チルトジブ 単位:t

ジブ長さ(m) 作業半径 (m)	10.0			18.0		
	オフセット			オフセット		
	5°	20°	40°	5°	20°	40°
11.0	4.9					
12.0	4.9					
14.0	4.9			2.9		
16.0	4.9	4.9		2.9		
18.0	4.9	4.7	4.4	2.9		
20.0	4.8	4.4	4.2	2.9	2.9	
22.0	4.5	4.2	4.0	2.9	2.9	
24.0	4.3	4.0	3.8	2.9	2.9	
26.0	4.1	3.9	3.7	2.9	2.9	2.7
28.0	3.6	3.7	3.5	2.9	2.8	2.6
30.0	3.1	3.3	3.4	2.9	2.6	2.5
32.0	2.6	2.8	3.0	2.7	2.5	2.4
34.0	2.2	2.4	2.5	2.5	2.5	2.3
36.0	1.8	2.0	2.1	2.1	2.4	2.3
38.0	1.4	1.6	1.8	1.8	2.1	2.2
40.0	1.2	1.3	1.4	1.5	1.7	2.0
42.0	0.9	1.0	1.1	1.2	1.4	1.7
44.0	0.6	0.8	0.8	0.9	1.2	1.4
46.0		0.5		0.7	0.9	1.1
48.0				0.5	0.7	0.9
50.0					0.5	0.6
θ (°)	42~ 82	41~ 82	46~ 82	47~ 82	48~ 82	50~ 82
標準フック	5.6t			5.6t		
フック重量	150kg			150kg		
標準巻掛本数	1			1		

注)カウンタウエイト 15t、アウトリガ張出幅 7.2m

【C性能】

51.2mブーム+油圧チルトジブ 単位:t

ジブ長さ(m) 作業半径 (m)	10.0			18.0		
	オフセット			オフセット		
	5°	20°	40°	5°	20°	40°
12.0	4.4					
14.0	4.4					
16.0	4.4	4.4		2.7		
18.0	4.4	4.4		2.7		
20.0	4.4	4.1	3.9	2.7		
22.0	4.2	4.0	3.7	2.7	2.7	
24.0	4.0	3.8	3.6	2.7	2.7	
26.0	3.8	3.6	3.5	2.7	2.7	2.6
28.0	3.6	3.5	3.3	2.7	2.6	2.5
30.0	3.0	3.3	3.2	2.7	2.5	2.4
32.0	2.5	2.8	3.0	2.6	2.4	2.3
34.0	2.1	2.3	2.5	2.4	2.3	2.2
36.0	1.7	1.9	2.1	2.0	2.2	2.1
38.0	1.4	1.6	1.7	1.7	2.0	2.1
40.0	1.1	1.3	1.4	1.4	1.7	2.0
42.0	0.8	1.0	1.1	1.1	1.4	1.7
44.0	0.6	0.7	0.8	0.9	1.1	1.4
46.0			0.6	0.7	0.9	1.1
48.0					0.7	0.9
50.0						0.6
θ (°)	46~ 82	48~ 82	47~ 82	53~ 82	54~ 82	54~ 82
標準フック	5.6t			5.6t		
フック重量	150kg			150kg		
標準巻掛本数	1			1		

注)カウンタウエイト 15t、アウトリガ張出幅 7.2m

油圧チルトジブ

【D性能】

11.1mブーム＋油圧チルトジブ

単位:t

ジブ長さ(m) 作業半径 (m)	10.0			18.0		
	オフセット			オフセット		
	5°	20°	40°	5°	20°	40°
3.0	11.0					
3.5	11.0					
4.0	11.0					
4.5	11.0					
5.0	11.0	11.0		5.6		
6.0	11.0	10.2		5.6		
7.0	11.0	9.4		5.6		
8.0	11.0	8.7	6.9	5.6		
9.0	10.1	8.1	6.6	5.6		
10.0	9.3	7.6	6.3	5.6	5.0	
11.0	8.6	7.2	6.1	5.6	4.7	
12.0	8.0	6.8	5.9	5.4	4.4	
14.0	7.0	6.2	5.5	4.7	4.0	
16.0	6.2	5.7		4.1	3.6	3.1
18.0				3.7	3.3	2.9
20.0				3.3	3.0	2.7
22.0				3.1	2.8	2.6
24.0				2.8	2.7	2.5
26.0				2.6	2.5	
θ (°)	33~ 82	38~ 82	54~ 82	20~ 82	28~ 82	47~ 82
標準フック	18t			5.6t		
フック重量	300kg			150kg		
標準巻掛本数	2			1		

注)カウンタウエイト 9t、アウトリガ張出幅 7.2m

【D性能】

33.2mブーム＋油圧チルトジブ

単位:t

ジブ長さ(m) 作業半径 (m)	10.0			18.0		
	オフセット			オフセット		
	5°	20°	40°	5°	20°	40°
8.0	10.1					
9.0	10.1					
10.0	10.1	8.9		4.2		
11.0	9.7	8.5		4.2		
12.0	9.3	8.1		4.2		
14.0	8.6	7.5	6.6	4.2		
16.0	8.0	7.0	6.2	4.2	4.2	
18.0	6.6	6.6	5.9	4.2	4.1	
20.0	5.3	5.8	5.6	4.2	3.9	3.2
22.0	4.3	4.7	5.1	4.2	3.8	3.0
24.0	3.5	3.8	4.2	4.2	3.6	2.9
26.0	2.8	3.1	3.4	3.5	3.5	2.9
28.0	2.3	2.5	2.7	2.9	3.4	2.8
30.0	1.8	2.0	2.2	2.4	2.8	2.7
32.0	1.4	1.6	1.7	2.0	2.3	2.6
34.0	1.1	1.2		1.6	1.9	2.3
36.0	0.7	0.9		1.3	1.6	1.8
38.0	0.5	0.6		1.0	1.2	1.5
40.0				0.8	1.0	1.1
42.0				0.5	0.7	
44.0					0.5	
θ (°)	24~ 82	27~ 82	46~ 82	36~ 82	35~ 82	47~ 82
標準フック	18t			5.6t		
フック重量	300kg			150kg		
標準巻掛本数	2			1		

注)カウンタウエイト 9t、アウトリガ張出幅 7.2m

【D性能】

47.9mブーム＋油圧チルトジブ

単位:t

ジブ長さ(m) 作業半径 (m)	10.0			18.0		
	オフセット			オフセット		
	5°	20°	40°	5°	20°	40°
11.0	4.9					
12.0	4.9					
14.0	4.9			2.9		
16.0	4.9	4.9		2.9		
18.0	4.9	4.7	4.4	2.9		
20.0	4.8	4.4	4.2	2.9	2.9	
22.0	4.5	4.2	4.0	2.9	2.9	
24.0	3.7	4.0	3.8	2.9	2.9	
26.0	3.0	3.3	3.7	2.9	2.9	2.7
28.0	2.4	2.7	3.0	2.8	2.8	2.6
30.0	2.0	2.2	2.5	2.3	2.6	2.5
32.0	1.5	1.8	2.0	1.9	2.3	2.4
34.0	1.2	1.4	1.6	1.5	1.9	2.3
36.0	0.9	1.1	1.2	1.2	1.5	1.9
38.0	0.6	0.8	0.9	0.9	1.2	1.5
40.0		0.5	0.6	0.7	0.9	1.2
42.0				0.7	0.9	
44.0				0.5	0.7	
θ (°)	51~ 82	50~ 82	52~ 82	57~ 82	56~ 82	59~ 82
標準フック	5.6t			5.6t		
フック重量	150kg			150kg		
標準巻掛本数	1			1		

注)カウンタウエイト 9t、アウトリガ張出幅 7.2m

【D性能】

51.2mブーム＋油圧チルトジブ

単位:t

ジブ長さ(m) 作業半径 (m)	10.0			18.0		
	オフセット			オフセット		
	5°	20°	40°	5°	20°	40°
12.0	4.4					
14.0	4.4					
16.0	4.4	4.4		2.7		
18.0	4.4	4.4		2.7		
20.0	4.4	4.1	3.9	2.7		
22.0	4.2	4.0	3.7	2.7	2.7	
24.0	3.6	3.8	3.6	2.7	2.7	
26.0	3.0	3.3	3.5	2.7	2.7	2.6
28.0	2.4	2.7	3.0	2.7	2.6	2.5
30.0	1.9	2.2	2.4	2.2	2.5	2.4
32.0	1.5	1.7	2.0	1.8	2.2	2.3
34.0	1.1	1.3	1.6	1.4	1.8	2.2
36.0	0.8	1.0	1.2	1.1	1.5	1.9
38.0	0.5	0.7	0.9	0.8	1.2	1.5
40.0			0.6	0.6	0.9	1.2
42.0					0.6	0.9
44.0						0.6
θ (°)	54~ 82	56~ 82	55~ 82	60~ 82	60~ 82	62~ 82
標準フック	5.6t			5.6t		
フック重量	150kg			150kg		
標準巻掛本数	1			1		

注)カウンタウエイト 9t、アウトリガ張出幅 7.2m

【E性能】

11.1mブーム+油圧チルトジブ 単位:t

ジブ長さ(m)	10.0			18.0		
	オフセット			オフセット		
作業半径(m)	5°	20°	40°	5°	20°	40°
3.0	11.0					
3.5	11.0					
4.0	11.0					
4.5	11.0					
5.0	11.0	11.0		5.6		
6.0	11.0	10.2		5.6		
7.0	11.0	9.4		5.6		
8.0	11.0	8.7	6.9	5.6		
9.0	10.1	8.1	6.6	5.6		
10.0	9.3	7.6	6.3	5.6	5.0	
11.0	8.6	7.2	6.1	5.6	4.7	
12.0	8.0	6.8	5.9	5.4	4.4	
14.0	7.0	6.2	5.5	4.7	4.0	
16.0	6.2	5.7		4.1	3.6	3.1
18.0				3.7	3.3	2.9
20.0				3.3	3.0	2.7
22.0				3.1	2.8	2.6
24.0				2.8	2.7	2.5
26.0				2.6	2.5	
θ(°)	33~82	38~82	54~82	20~82	28~82	47~82
標準フック	18t			5.6t		
フック重量	300kg			150kg		
標準巻掛本数	2			1		

注)カウンタウエイト 5t、アウトリガ張出幅 7.2m

【E性能】

33.2mブーム+油圧チルトジブ 単位:t

ジブ長さ(m)	10.0			18.0		
	オフセット			オフセット		
作業半径(m)	5°	20°	40°	5°	20°	40°
8.0	10.1					
9.0	10.1					
10.0	10.1	8.9		4.2		
11.0	9.7	8.5		4.2		
12.0	9.3	8.1		4.2		
14.0	8.6	7.5	6.6	4.2		
16.0	6.7	7.0	6.2	4.2	4.2	
18.0	5.2	5.7	5.9	4.2	4.1	
20.0	4.1	4.5	5.0	4.2	3.9	3.2
22.0	3.2	3.6	4.0	4.0	3.8	3.0
24.0	2.5	2.8	3.2	3.2	3.6	2.9
26.0	1.9	2.2	2.5	2.6	3.1	2.9
28.0	1.4	1.7	1.9	2.1	2.5	2.8
30.0	1.0	1.2	1.4	1.6	2.1	2.5
32.0	0.7	0.9	1.0	1.3	1.6	2.0
34.0		0.5		1.0	1.3	1.6
36.0				0.7	0.9	1.2
38.0					0.7	0.9
40.0						0.6
θ(°)	41~82	39~82	46~82	47~82	47~82	47~82
標準フック	18t			5.6t		
フック重量	300kg			150kg		
標準巻掛本数	2			1		

注)カウンタウエイト 5t、アウトリガ張出幅 7.2m

【E性能】

47.9mブーム+油圧チルトジブ 単位:t

ジブ長さ(m)	10.0			18.0		
	オフセット			オフセット		
作業半径(m)	5°	20°	40°	5°	20°	40°
11.0	4.9					
12.0	4.9					
14.0	4.9			2.9		
16.0	4.9	4.9		2.9		
18.0	4.9	4.7	4.4	2.9		
20.0	4.3	4.4	4.2	2.9	2.9	
22.0	3.4	3.8	4.0	2.9	2.9	
24.0	2.7	3.0	3.4	2.9	2.9	
26.0	2.1	2.4	2.7	2.5	2.9	2.7
28.0	1.6	1.9	2.2	2.0	2.5	2.6
30.0	1.2	1.4	1.7	1.5	2.0	2.5
32.0	0.8	1.1	1.3	1.2	1.6	2.0
34.0		0.7	0.9	0.8	1.2	1.6
36.0				0.6	0.9	1.3
38.0					0.6	0.9
40.0						0.7
θ(°)	59~82	58~82	60~82	61~82	63~82	64~82
標準フック	5.6t			5.6t		
フック重量	150kg			150kg		
標準巻掛本数	1			1		

注)カウンタウエイト 5t、アウトリガ張出幅 7.2m

【E性能】

51.2mブーム+油圧チルトジブ 単位:t

ジブ長さ(m)	10.0			18.0		
	オフセット			オフセット		
作業半径(m)	5°	20°	40°	5°	20°	40°
12.0	4.4					
14.0	4.4					
16.0	4.4	4.4		2.7		
18.0	4.4	4.4		2.7		
20.0	4.3	4.1	3.9	2.7		
22.0	3.4	3.8	3.7	2.7	2.7	
24.0	2.6	3.0	3.4	2.7	2.7	
26.0	2.1	2.4	2.7	2.4	2.7	2.6
28.0	1.6	1.8	2.1	1.9	2.4	2.5
30.0	1.1	1.4	1.7	1.5	1.9	2.4
32.0		1.0	1.2	1.1	1.5	2.0
34.0			0.9	0.8	1.2	1.6
36.0					0.8	1.2
38.0					0.6	0.9
40.0						0.6
θ(°)	64~82	63~82	63~82	66~82	65~82	66~82
標準フック	5.6t			5.6t		
フック重量	150kg			150kg		
標準巻掛本数	1			1		

注)カウンタウエイト 5t、アウトリガ張出幅 7.2m

油圧チルトジブ

【G性能】

11.1mブーム＋油圧チルトジブ

単位:t

ジブ長さ(m) 作業半径 (m)	10.0			18.0		
	オフセット			オフセット		
	5°	20°	40°	5°	20°	40°
3.0	11.0					
3.5	11.0					
4.0	11.0					
4.5	11.0					
5.0	11.0	11.0		5.6		
6.0	11.0	10.2		5.6		
7.0	11.0	9.4		5.6		
8.0	11.0	8.7	6.9	5.6		
9.0	10.1	8.1	6.6	5.6		
10.0	9.3	7.6	6.3	5.6	5.0	
11.0	8.6	7.2	6.1	5.6	4.7	
12.0	8.0	6.8	5.9	5.4	4.4	
14.0	7.0	6.2	5.5	4.7	4.0	
16.0	6.2	5.7		4.1	3.6	3.1
18.0				3.7	3.3	2.9
20.0				3.3	3.0	2.7
22.0				3.1	2.8	2.6
24.0				2.8	2.7	2.5
26.0				2.6	2.5	
θ (°)	33~ 82	38~ 82	54~ 82	20~ 82	28~ 82	47~ 82
標準フック	18t			5.6t		
フック重量	300kg			150kg		
標準巻掛本数	2			1		

注)カウンタウエイト 25t、アウトリガ張出幅 6.0m

【G性能】

33.2mブーム＋油圧チルトジブ

単位:t

ジブ長さ(m) 作業半径 (m)	10.0			18.0		
	オフセット			オフセット		
	5°	20°	40°	5°	20°	40°
8.0	10.1					
9.0	10.1					
10.0	10.1	8.9		4.2		
11.0	9.7	8.5		4.2		
12.0	9.3	8.1		4.2		
14.0	8.6	7.5	6.6	4.2		
16.0	8.0	7.0	6.2	4.2	4.2	
18.0	7.4	6.6	5.9	4.2	4.1	
20.0	6.9	6.2	5.6	4.2	3.9	3.2
22.0	6.5	5.9	5.4	4.2	3.8	3.0
24.0	5.8	5.6	5.1	4.2	3.6	2.9
26.0	4.9	5.2	5.0	4.0	3.5	2.9
28.0	4.2	4.4	4.7	3.9	3.4	2.8
30.0	3.6	3.8	4.0	3.7	3.2	2.7
32.0	3.1	3.2	3.4	3.6	3.1	2.6
34.0	2.6	2.8		3.2	3.0	2.6
36.0	2.2	2.3		2.8	2.9	2.5
38.0	1.9	1.9		2.4	2.6	2.5
40.0	1.6			2.1	2.3	2.5
42.0				1.8	2.0	
44.0				1.5	1.7	
46.0				1.3	1.4	
48.0				1.1		
θ (°)	15~ 82	27~ 82	46~ 82	18~ 82	29~ 82	47~ 82
標準フック	18t			5.6t		
フック重量	300kg			150kg		
標準巻掛本数	2			1		

注)カウンタウエイト 25t、アウトリガ張出幅 6.0m

【G性能】

47.9mブーム＋油圧チルトジブ

単位:t

ジブ長さ(m) 作業半径 (m)	10.0			18.0		
	オフセット			オフセット		
	5°	20°	40°	5°	20°	40°
11.0	4.9					
12.0	4.9					
14.0	4.9			2.9		
16.0	4.9	4.9		2.9		
18.0	4.9	4.7	4.4	2.9		
20.0	4.8	4.4	4.2	2.9	2.9	
22.0	4.5	4.2	4.0	2.9	2.9	
24.0	4.3	4.0	3.8	2.9	2.9	
26.0	4.1	3.9	3.7	2.9	2.9	2.7
28.0	3.9	3.7	3.5	2.9	2.8	2.6
30.0	3.7	3.6	3.4	2.9	2.6	2.5
32.0	3.2	3.4	3.3	2.7	2.5	2.4
34.0	2.8	3.0	3.1	2.6	2.5	2.3
36.0	2.3	2.5	2.7	2.5	2.4	2.3
38.0	2.0	2.1	2.3	2.3	2.3	2.2
40.0	1.7	1.8	1.9	2.0	2.2	2.1
42.0	1.4	1.5	1.6	1.7	1.9	2.1
44.0	1.1	1.2	1.3	1.4	1.7	1.9
46.0	0.8	0.9		1.2	1.4	1.6
48.0	0.6	0.7		0.9	1.2	1.3
50.0				0.7	0.9	1.1
52.0				0.5	0.7	0.8
θ (°)	35~ 82	37~ 82	46~ 82	42~ 82	45~ 82	47~ 82
標準フック	5.6t			5.6t		
フック重量	150kg			150kg		
標準巻掛本数	1			1		

注)カウンタウエイト 25t、アウトリガ張出幅 6.0m

【G性能】

51.2mブーム＋油圧チルトジブ

単位:t

ジブ長さ(m) 作業半径 (m)	10.0			18.0		
	オフセット			オフセット		
	5°	20°	40°	5°	20°	40°
12.0	4.4					
14.0	4.4					
16.0	4.4	4.4		2.7		
18.0	4.4	4.4		2.7		
20.0	4.4	4.1	3.9	2.7		
22.0	4.2	4.0	3.7	2.7	2.7	
24.0	4.0	3.8	3.6	2.7	2.7	
26.0	3.8	3.6	3.5	2.7	2.7	2.6
28.0	3.6	3.5	3.3	2.7	2.6	2.5
30.0	3.4	3.3	3.2	2.7	2.5	2.4
32.0	3.2	3.1	3.1	2.6	2.4	2.3
34.0	2.7	2.9	3.0	2.5	2.3	2.2
36.0	2.3	2.5	2.7	2.4	2.2	2.1
38.0	1.9	2.1	2.3	2.2	2.2	2.1
40.0	1.6	1.8	1.9	1.9	2.1	2.0
42.0	1.3	1.5	1.6	1.6	1.9	1.9
44.0	1.0	1.2	1.3	1.4	1.6	1.9
46.0	0.8	0.9	1.0	1.1	1.3	1.6
48.0	0.5	0.6		0.8	1.1	1.3
50.0				0.6	0.8	1.1
52.0					0.6	0.8
54.0						0.5
θ (°)	40~ 82	42~ 82	47~ 82	49~ 82	49~ 82	48~ 82
標準フック	5.6t			5.6t		
フック重量	150kg			150kg		
標準巻掛本数	1			1		

注)カウンタウエイト 25t、アウトリガ張出幅 6.0m

【H性能】

11.1mブーム+油圧チルトジブ 単位:t

ジブ長さ(m) 作業半径 (m)	10.0			18.0		
	オフセット			オフセット		
	5°	20°	40°	5°	20°	40°
3.0	11.0					
3.5	11.0					
4.0	11.0					
4.5	11.0					
5.0	11.0	11.0		5.6		
6.0	11.0	10.2		5.6		
7.0	11.0	9.4		5.6		
8.0	11.0	8.7	6.9	5.6		
9.0	10.1	8.1	6.6	5.6		
10.0	9.3	7.6	6.3	5.6	5.0	
11.0	8.6	7.2	6.1	5.6	4.7	
12.0	8.0	6.8	5.9	5.4	4.4	
14.0	7.0	6.2	5.5	4.7	4.0	
16.0	6.2	5.7		4.1	3.6	3.1
18.0				3.7	3.3	2.9
20.0				3.3	3.0	2.7
22.0				3.1	2.8	2.6
24.0				2.8	2.7	2.5
26.0				2.6	2.5	
θ (°)	33~ 82	38~ 82	54~ 82	20~ 82	28~ 82	47~ 82
標準フック	18t			5.6t		
フック重量	300kg			150kg		
標準巻掛本数	2			1		

注)カウンタウエイト 21t、アウトリガ張出幅 6.0m

【H性能】

33.2mブーム+油圧チルトジブ 単位:t

ジブ長さ(m) 作業半径 (m)	10.0			18.0		
	オフセット			オフセット		
	5°	20°	40°	5°	20°	40°
8.0	10.1					
9.0	10.1					
10.0	10.1	8.9		4.2		
11.0	9.7	8.5		4.2		
12.0	9.3	8.1		4.2		
14.0	8.6	7.5	6.6	4.2		
16.0	8.0	7.0	6.2	4.2	4.2	
18.0	7.4	6.6	5.9	4.2	4.1	
20.0	6.9	6.2	5.6	4.2	3.9	3.2
22.0	5.9	5.9	5.4	4.2	3.8	3.0
24.0	4.9	5.2	5.1	4.2	3.6	2.9
26.0	4.1	4.4	4.7	4.0	3.5	2.9
28.0	3.5	3.7	3.9	3.9	3.4	2.8
30.0	2.9	3.1	3.3	3.5	3.2	2.7
32.0	2.4	2.6	2.7	3.0	3.1	2.6
34.0	2.0	2.2		2.6	2.9	2.6
36.0	1.7	1.8		2.2	2.5	2.5
38.0	1.4	1.4		1.9	2.1	2.4
40.0	1.1			1.6	1.8	2.0
42.0				1.3	1.5	
44.0				1.1	1.2	
46.0				0.9	1.0	
48.0				0.6		
θ (°)	15~ 82	27~ 82	46~ 82	18~ 82	29~ 82	47~ 82
標準フック	18t			5.6t		
フック重量	300kg			150kg		
標準巻掛本数	2			1		

注)カウンタウエイト 21t、アウトリガ張出幅 6.0m

【H性能】

47.9mブーム+油圧チルトジブ 単位:t

ジブ長さ(m) 作業半径 (m)	10.0			18.0		
	オフセット			オフセット		
	5°	20°	40°	5°	20°	40°
11.0	4.9					
12.0	4.9					
14.0	4.9			2.9		
16.0	4.9	4.9		2.9		
18.0	4.9	4.7	4.4	2.9		
20.0	4.8	4.4	4.2	2.9	2.9	
22.0	4.5	4.2	4.0	2.9	2.9	
24.0	4.3	4.0	3.8	2.9	2.9	
26.0	4.1	3.9	3.7	2.9	2.9	2.7
28.0	3.6	3.7	3.5	2.9	2.8	2.6
30.0	3.1	3.3	3.4	2.9	2.6	2.5
32.0	2.6	2.8	3.0	2.7	2.5	2.4
34.0	2.2	2.4	2.6	2.5	2.5	2.3
36.0	1.8	2.0	2.1	2.1	2.4	2.3
38.0	1.5	1.6	1.8	1.8	2.1	2.2
40.0	1.2	1.3	1.4	1.5	1.8	2.1
42.0	0.9	1.0	1.1	1.2	1.5	1.7
44.0	0.6	0.7	0.9	1.0	1.2	1.4
46.0		0.5		0.7	1.0	1.2
48.0				0.5	0.7	0.9
50.0					0.5	0.7
θ (°)	42~ 82	41~ 82	46~ 82	47~ 82	48~ 82	50~ 82
標準フック	5.6t			5.6t		
フック重量	150kg			150kg		
標準巻掛本数	1			1		

注)カウンタウエイト 21t、アウトリガ張出幅 6.0m

【H性能】

51.2mブーム+油圧チルトジブ 単位:t

ジブ長さ(m) 作業半径 (m)	10.0			18.0		
	オフセット			オフセット		
	5°	20°	40°	5°	20°	40°
12.0	4.4					
14.0	4.4					
16.0	4.4	4.4		2.7		
18.0	4.4	4.4		2.7		
20.0	4.4	4.1	3.9	2.7		
22.0	4.2	4.0	3.7	2.7	2.7	
24.0	4.0	3.8	3.6	2.7	2.7	
26.0	3.8	3.6	3.5	2.7	2.7	2.6
28.0	3.6	3.5	3.3	2.7	2.6	2.5
30.0	3.0	3.3	3.2	2.7	2.5	2.4
32.0	2.5	2.8	3.0	2.6	2.4	2.3
34.0	2.1	2.3	2.5	2.4	2.3	2.2
36.0	1.7	1.9	2.1	2.0	2.2	2.1
38.0	1.4	1.6	1.7	1.7	2.0	2.1
40.0	1.1	1.3	1.4	1.4	1.7	2.0
42.0	0.8	1.0	1.1	1.2	1.4	1.7
44.0	0.5	0.7	0.8	0.9	1.2	1.4
46.0			0.5	0.6	0.9	1.1
48.0					0.7	0.9
50.0						0.6
θ (°)	46~ 82	48~ 82	47~ 82	53~ 82	54~ 82	54~ 82
標準フック	5.6t			5.6t		
フック重量	150kg			150kg		
標準巻掛本数	1			1		

注)カウンタウエイト 21t、アウトリガ張出幅 6.0m

油圧チルトジブ

【I性能】

11.1mブーム＋油圧チルトジブ

単位:t

ジブ長さ(m) 作業半径 (m)	10.0			18.0		
	オフセット			オフセット		
	5°	20°	40°	5°	20°	40°
3.0	11.0					
3.5	11.0					
4.0	11.0					
4.5	11.0					
5.0	11.0	11.0		5.6		
6.0	11.0	10.2		5.6		
7.0	11.0	9.4		5.6		
8.0	11.0	8.7	6.9	5.6		
9.0	10.1	8.1	6.6	5.6		
10.0	9.3	7.6	6.3	5.6	5.0	
11.0	8.6	7.2	6.1	5.6	4.7	
12.0	8.0	6.8	5.9	5.4	4.4	
14.0	7.0	6.2	5.5	4.7	4.0	
16.0	6.2	5.7		4.1	3.6	3.1
18.0				3.7	3.3	2.9
20.0				3.3	3.0	2.7
22.0				3.1	2.8	2.6
24.0				2.8	2.7	2.5
26.0				2.6	2.5	
θ (°)	33~ 82	38~ 82	54~ 82	20~ 82	28~ 82	47~ 82
標準フック	18t			5.6t		
フック重量	300kg			150kg		
標準巻掛本数	2			1		

注)カウンタウエイト 15t、アウトリガ張出幅 6.0m

【I性能】

33.2mブーム＋油圧チルトジブ

単位:t

ジブ長さ(m) 作業半径 (m)	10.0			18.0		
	オフセット			オフセット		
	5°	20°	40°	5°	20°	40°
8.0	10.1					
9.0	10.1					
10.0	10.1	8.9		4.2		
11.0	9.7	8.5		4.2		
12.0	9.3	8.1		4.2		
14.0	8.6	7.5	6.6	4.2		
16.0	8.0	7.0	6.2	4.2	4.2	
18.0	6.7	6.6	5.9	4.2	4.1	
20.0	5.4	5.9	5.6	4.2	3.9	3.2
22.0	4.4	4.8	5.2	4.2	3.8	3.0
24.0	3.6	3.9	4.3	4.2	3.6	2.9
26.0	3.0	3.2	3.5	3.6	3.5	2.9
28.0	2.4	2.6	2.9	3.0	3.4	2.8
30.0	1.9	2.1	2.3	2.5	2.9	2.7
32.0	1.5	1.7	1.8	2.1	2.5	2.6
34.0	1.2	1.3		1.7	2.1	2.4
36.0	0.9	1.0		1.4	1.7	2.0
38.0	0.6	0.7		1.1	1.4	1.6
40.0				0.9	1.1	1.2
42.0				0.6	0.8	
44.0					0.6	
θ (°)	24~ 82	27~ 82	46~ 82	36~ 82	35~ 82	47~ 82
標準フック	18t			5.6t		
フック重量	300kg			150kg		
標準巻掛本数	2			1		

注)カウンタウエイト 15t、アウトリガ張出幅 6.0m

【I性能】

47.9mブーム＋油圧チルトジブ

単位:t

ジブ長さ(m) 作業半径 (m)	10.0			18.0		
	オフセット			オフセット		
	5°	20°	40°	5°	20°	40°
11.0	4.9					
12.0	4.9					
14.0	4.9			2.9		
16.0	4.9	4.9		2.9		
18.0	4.9	4.7	4.4	2.9		
20.0	4.8	4.4	4.2	2.9	2.9	
22.0	4.5	4.2	4.0	2.9	2.9	
24.0	3.8	4.0	3.8	2.9	2.9	
26.0	3.1	3.4	3.7	2.9	2.9	2.7
28.0	2.6	2.8	3.1	2.9	2.8	2.6
30.0	2.1	2.3	2.6	2.4	2.6	2.5
32.0	1.7	1.9	2.1	2.0	2.4	2.4
34.0	1.3	1.5	1.7	1.6	2.0	2.3
36.0	1.0	1.2	1.3	1.3	1.6	2.0
38.0	0.7	0.9	1.0	1.0	1.3	1.7
40.0		0.6	0.7	0.8	1.0	1.3
42.0				0.5	0.8	1.1
44.0					0.6	0.8
46.0						0.5
θ (°)	51~ 82	50~ 82	52~ 82	55~ 82	56~ 82	56~ 82
標準フック	5.6t			5.6t		
フック重量	150kg			150kg		
標準巻掛本数	1			1		

注)カウンタウエイト 15t、アウトリガ張出幅 6.0m

【I性能】

51.2mブーム＋油圧チルトジブ

単位:t

ジブ長さ(m) 作業半径 (m)	10.0			18.0		
	オフセット			オフセット		
	5°	20°	40°	5°	20°	40°
12.0	4.4					
14.0	4.4					
16.0	4.4	4.4		2.7		
18.0	4.4	4.4		2.7		
20.0	4.4	4.1	3.9	2.7		
22.0	4.2	4.0	3.7	2.7	2.7	
24.0	3.8	3.8	3.6	2.7	2.7	
26.0	3.1	3.4	3.5	2.7	2.7	2.6
28.0	2.5	2.8	3.1	2.7	2.6	2.5
30.0	2.0	2.3	2.6	2.4	2.5	2.4
32.0	1.6	1.8	2.1	1.9	2.4	2.3
34.0	1.3	1.5	1.7	1.6	2.0	2.2
36.0	0.9	1.1	1.3	1.2	1.6	2.0
38.0	0.7	0.8	1.0	0.9	1.3	1.6
40.0		0.5	0.7	0.7	1.0	1.3
42.0					0.7	1.0
44.0					0.5	0.8
46.0						0.5
θ (°)	54~ 82	53~ 82	55~ 82	60~ 82	58~ 82	59~ 82
標準フック	5.6t			5.6t		
フック重量	150kg			150kg		
標準巻掛本数	1			1		

注)カウンタウエイト 15t、アウトリガ張出幅 6.0m

【J性能】

11.1mブーム+油圧チルトジブ 単位:t

ジブ長さ(m)	10.0			18.0		
	オフセット			オフセット		
作業半径(m)	5°	20°	40°	5°	20°	40°
3.0	11.0					
3.5	11.0					
4.0	11.0					
4.5	11.0					
5.0	11.0	11.0		5.6		
6.0	11.0	10.2		5.6		
7.0	11.0	9.4		5.6		
8.0	11.0	8.7	6.9	5.6		
9.0	10.1	8.1	6.6	5.6		
10.0	9.3	7.6	6.3	5.6	5.0	
11.0	8.6	7.2	6.1	5.6	4.7	
12.0	8.0	6.8	5.9	5.4	4.4	
14.0	7.0	6.2	5.5	4.7	4.0	
16.0	6.2	5.7		4.1	3.6	3.1
18.0				3.7	3.3	2.9
20.0				3.3	3.0	2.7
22.0				3.1	2.8	2.6
24.0				2.8	2.7	2.5
26.0				2.6	2.5	
θ(°)	33~82	38~82	54~82	20~82	28~82	47~82
標準フック	18t			5.6t		
フック重量	300kg			150kg		
標準巻掛本数	2			1		

注)カウンタウエイト 9t、アウトリガ張出幅 6.0m

【J性能】

33.2mブーム+油圧チルトジブ 単位:t

ジブ長さ(m)	10.0			18.0		
	オフセット			オフセット		
作業半径(m)	5°	20°	40°	5°	20°	40°
8.0	10.1					
9.0	10.1					
10.0	10.1	8.9		4.2		
11.0	9.7	8.5		4.2		
12.0	9.3	8.1		4.2		
14.0	8.2	7.5	6.6	4.2		
16.0	6.3	6.9	6.2	4.2	4.2	
18.0	4.9	5.4	5.9	4.2	4.1	
20.0	3.8	4.3	4.7	4.2	3.9	3.2
22.0	3.0	3.4	3.7	3.7	3.8	3.0
24.0	2.3	2.6	3.0	3.0	3.6	2.9
26.0	1.8	2.0	2.3	2.4	2.9	2.9
28.0	1.3	1.5	1.8	1.9	2.4	2.8
30.0	0.9	1.1	1.3	1.5	1.9	2.4
32.0	0.6	0.7	0.9	1.2	1.5	1.9
34.0				0.9	1.2	1.5
36.0				0.6	0.9	1.1
38.0					0.6	0.8
40.0						0.5
θ(°)	41~82	43~82	46~82	47~82	47~82	47~82
標準フック	18t			5.6t		
フック重量	300kg			150kg		
標準巻掛本数	2			1		

注)カウンタウエイト 9t、アウトリガ張出幅 6.0m

【J性能】

47.9mブーム+油圧チルトジブ 単位:t

ジブ長さ(m)	10.0			18.0		
	オフセット			オフセット		
作業半径(m)	5°	20°	40°	5°	20°	40°
11.0	4.9					
12.0	4.9					
14.0	4.9			2.9		
16.0	4.9	4.9		2.9		
18.0	4.9	4.7	4.4	2.9		
20.0	4.0	4.4	4.2	2.9	2.9	
22.0	3.2	3.6	4.0	2.9	2.9	
24.0	2.5	2.9	3.2	2.9	2.9	
26.0	1.9	2.3	2.6	2.3	2.9	2.7
28.0	1.5	1.7	2.0	1.8	2.3	2.6
30.0	1.1	1.3	1.6	1.4	1.9	2.4
32.0	0.7	0.9	1.2	1.1	1.5	1.9
34.0			0.8	0.8	1.1	1.5
36.0				0.5	0.8	1.2
38.0					0.5	0.9
40.0						0.6
θ(°)	59~82	61~82	60~82	61~82	63~82	64~82
標準フック	5.6t			5.6t		
フック重量	150kg			150kg		
標準巻掛本数	1			1		

注)カウンタウエイト 9t、アウトリガ張出幅 6.0m

【J性能】

51.2mブーム+油圧チルトジブ 単位:t

ジブ長さ(m)	10.0			18.0		
	オフセット			オフセット		
作業半径(m)	5°	20°	40°	5°	20°	40°
12.0	4.4					
14.0	4.4					
16.0	4.4	4.4		2.7		
18.0	4.4	4.4		2.7		
20.0	4.0	4.1	3.9	2.7		
22.0	3.1	3.5	3.7	2.7	2.7	
24.0	2.5	2.8	3.2	2.7	2.7	
26.0	1.9	2.2	2.6	2.2	2.7	2.6
28.0	1.4	1.7	2.0	1.8	2.3	2.5
30.0	1.0	1.3	1.5	1.3	1.8	2.3
32.0		0.9	1.1	1.0	1.4	1.9
34.0				0.7	1.1	1.5
36.0					0.8	1.2
38.0						0.8
θ(°)	64~82	63~82	65~82	66~82	67~82	68~82
標準フック	5.6t			5.6t		
フック重量	150kg			150kg		
標準巻掛本数	1			1		

注)カウンタウエイト 9t、アウトリガ張出幅 6.0m

油圧チルトジブ

【K性能】

11.1mブーム＋油圧チルトジブ

単位:t

ジブ長さ(m) 作業半径 (m)	10.0			18.0		
	オフセット			オフセット		
	5°	20°	40°	5°	20°	40°
3.0	11.0					
3.5	11.0					
4.0	11.0					
4.5	11.0					
5.0	11.0	11.0		5.6		
6.0	11.0	10.2		5.6		
7.0	11.0	9.4		5.6		
8.0	11.0	8.7	6.9	5.6		
9.0	10.1	8.1	6.6	5.6		
10.0	9.3	7.6	6.3	5.6	5.0	
11.0	8.6	7.2	6.1	5.6	4.7	
12.0	8.0	6.8	5.9	5.4	4.4	
14.0	7.0	6.2	5.5	4.7	4.0	
16.0	6.2	5.7		4.1	3.6	3.1
18.0				3.7	3.3	2.9
20.0				3.3	3.0	2.7
22.0				3.1	2.8	2.6
24.0				2.8	2.7	2.5
26.0				2.6	2.5	
$\theta (^{\circ})$	33~ 82	38~ 82	54~ 82	20~ 82	28~ 82	47~ 82
標準フック	18t			5.6t		
フック重量	300kg			150kg		
標準巻掛本数	2			1		

注)カウンタウエイト 5t、アウトリガ張出幅 6.0m

【K性能】

33.2mブーム＋油圧チルトジブ

単位:t

ジブ長さ(m) 作業半径 (m)	10.0			18.0		
	オフセット			オフセット		
	5°	20°	40°	5°	20°	40°
8.0	10.1					
9.0	10.1					
10.0	10.1	8.9		4.2		
11.0	9.7	8.5		4.2		
12.0	8.8	8.1		4.2		
14.0	6.4	7.1	6.6	4.2		
16.0	4.8	5.4	6.1	4.2	4.2	
18.0	3.6	4.1	4.7	4.2	4.1	
20.0	2.7	3.1	3.6	3.5	3.9	3.2
22.0	2.0	2.4	2.7	2.7	3.4	3.0
24.0	1.4	1.7	2.1	2.1	2.7	2.9
26.0	1.0	1.2	1.5	1.6	2.1	2.7
28.0	0.6	0.8	1.0	1.2	1.6	2.1
30.0			0.6	0.8	1.2	1.7
32.0				0.5	0.9	1.2
34.0					0.6	0.9
36.0						0.6
$\theta (^{\circ})$	49~ 82	51~ 82	50~ 82	53~ 82	54~ 82	55~ 82
標準フック	18t			5.6t		
フック重量	300kg			150kg		
標準巻掛本数	2			1		

注)カウンタウエイト 5t、アウトリガ張出幅 6.0m

【K性能】

47.9mブーム＋油圧チルトジブ

単位:t

ジブ長さ(m) 作業半径 (m)	10.0			18.0		
	オフセット			オフセット		
	5°	20°	40°	5°	20°	40°
11.0	4.9					
12.0	4.9					
14.0	4.9			2.9		
16.0	4.9	4.9		2.9		
18.0	3.9	4.4	4.4	2.9		
20.0	2.9	3.4	3.9	2.9	2.9	
22.0	2.2	2.6	3.0	2.6	2.9	
24.0	1.6	2.0	2.3	2.0	2.6	
26.0	1.1	1.4	1.8	1.5	2.0	2.7
28.0		1.0	1.3	1.1	1.6	2.1
30.0					1.2	1.7
32.0					0.8	1.3
34.0						0.9
$\theta (^{\circ})$	66~ 82	65~ 82	68~ 82	69~ 82	69~ 82	70~ 82
標準フック	5.6t			5.6t		
フック重量	150kg			150kg		
標準巻掛本数	1			1		

注)カウンタウエイト 5t、アウトリガ張出幅 6.0m

【K性能】

51.2mブーム＋油圧チルトジブ

単位:t

ジブ長さ(m) 作業半径 (m)	10.0			18.0		
	オフセット			オフセット		
	5°	20°	40°	5°	20°	40°
12.0	4.4					
14.0	4.4					
16.0	4.4	4.4		2.7		
18.0	3.8	4.3		2.7		
20.0	2.9	3.3	3.8	2.7		
22.0	2.1	2.5	3.0	2.5	2.7	
24.0	1.6	1.9	2.3	1.9	2.6	
26.0		1.4	1.7	1.4	2.0	2.6
28.0			1.2	1.0	1.5	2.1
30.0					1.1	1.6
32.0						1.2
34.0						0.9
$\theta (^{\circ})$	70~ 82	69~ 82	70~ 82	71~ 82	72~ 82	72~ 82
標準フック	5.6t			5.6t		
フック重量	150kg			150kg		
標準巻掛本数	1			1		

注)カウンタウエイト 5t、アウトリガ張出幅 6.0m

【M性能】

11.1mブーム+油圧チルトジブ 単位:t

ジブ長さ(m) 作業半径 (m)	10.0			18.0		
	オフセット			オフセット		
	5°	20°	40°	5°	20°	40°
3.0	11.0					
3.5	11.0					
4.0	11.0					
4.5	11.0					
5.0	11.0	11.0		5.6		
6.0	11.0	10.2		5.6		
7.0	11.0	9.4		5.6		
8.0	11.0	8.7	6.9	5.6		
9.0	10.1	8.1	6.6	5.6		
10.0	9.3	7.6	6.3	5.6	5.0	
11.0	8.6	7.2	6.1	5.6	4.7	
12.0	8.0	6.8	5.9	5.4	4.4	
14.0	7.0	6.2	5.5	4.7	4.0	
16.0	6.2	5.7		4.1	3.6	3.1
18.0				3.7	3.3	2.9
20.0				3.3	3.0	2.7
22.0				3.1	2.8	2.6
24.0				2.8	2.7	2.5
26.0				2.6	2.5	
$\theta (^{\circ})$	33~ 82	38~ 82	54~ 82	20~ 82	28~ 82	47~ 82
標準フック	18t			5.6t		
フック重量	300kg			150kg		
標準巻掛本数	2			1		

注)カウンタウエイト 25t、アウトリガ張出幅 5.0m

【M性能】

33.2mブーム+油圧チルトジブ 単位:t

ジブ長さ(m) 作業半径 (m)	10.0			18.0		
	オフセット			オフセット		
	5°	20°	40°	5°	20°	40°
8.0	10.1					
9.0	10.1					
10.0	10.1	8.9		4.2		
11.0	9.7	8.5		4.2		
12.0	9.3	8.1		4.2		
14.0	8.6	7.5	6.6	4.2		
16.0	8.0	7.0	6.2	4.2	4.2	
18.0	7.4	6.6	5.9	4.2	4.1	
20.0	6.4	6.2	5.6	4.2	3.9	3.2
22.0	5.3	5.6	5.4	4.2	3.8	3.0
24.0	4.4	4.7	5.0	4.2	3.6	2.9
26.0	3.7	4.0	4.2	4.0	3.5	2.9
28.0	3.1	3.3	3.5	3.7	3.4	2.8
30.0	2.6	2.8	3.0	3.2	3.2	2.7
32.0	2.1	2.3	2.4	2.7	3.1	2.6
34.0	1.8	1.9		2.3	2.6	2.6
36.0	1.4	1.5		2.0	2.2	2.5
38.0	1.1	1.2		1.6	1.9	2.1
40.0	0.8			1.4	1.6	1.7
42.0				1.1	1.3	
44.0				0.9	1.0	
46.0				0.6	0.8	
$\theta (^{\circ})$	15~ 82	27~ 82	46~ 82	25~ 82	29~ 82	47~ 82
標準フック	18t			5.6t		
フック重量	300kg			150kg		
標準巻掛本数	2			1		

注)カウンタウエイト 25t、アウトリガ張出幅 5.0m

【M性能】

47.9mブーム+油圧チルトジブ 単位:t

ジブ長さ(m) 作業半径 (m)	10.0			18.0		
	オフセット			オフセット		
	5°	20°	40°	5°	20°	40°
11.0	4.9					
12.0	4.9					
14.0	4.9			2.9		
16.0	4.9	4.9		2.9		
18.0	4.9	4.7	4.4	2.9		
20.0	4.8	4.4	4.2	2.9	2.9	
22.0	4.5	4.2	4.0	2.9	2.9	
24.0	4.3	4.0	3.8	2.9	2.9	
26.0	3.9	3.9	3.7	2.9	2.9	2.7
28.0	3.3	3.5	3.5	2.9	2.8	2.6
30.0	2.7	3.0	3.2	2.9	2.6	2.5
32.0	2.3	2.5	2.7	2.6	2.5	2.4
34.0	1.9	2.1	2.3	2.2	2.5	2.3
36.0	1.5	1.7	1.9	1.9	2.2	2.3
38.0	1.2	1.4	1.5	1.5	1.8	2.2
40.0	0.9	1.1	1.2	1.3	1.5	1.8
42.0	0.6	0.8	0.9	1.0	1.3	1.5
44.0		0.5	0.6	0.8	1.0	1.2
46.0				0.5	0.8	1.0
48.0					0.5	0.7
50.0						0.5
$\theta (^{\circ})$	46~ 82	44~ 82	46~ 82	50~ 82	51~ 82	50~ 82
標準フック	5.6t			5.6t		
フック重量	150kg			150kg		
標準巻掛本数	1			1		

注)カウンタウエイト 25t、アウトリガ張出幅 5.0m

【M性能】

51.2mブーム+油圧チルトジブ 単位:t

ジブ長さ(m) 作業半径 (m)	10.0			18.0		
	オフセット			オフセット		
	5°	20°	40°	5°	20°	40°
12.0	4.4					
14.0	4.4					
16.0	4.4	4.4		2.7		
18.0	4.4	4.4		2.7		
20.0	4.4	4.1	3.9	2.7		
22.0	4.2	4.0	3.7	2.7	2.7	
24.0	4.0	3.8	3.6	2.7	2.7	
26.0	3.8	3.6	3.5	2.7	2.7	2.6
28.0	3.2	3.5	3.3	2.7	2.6	2.5
30.0	2.7	2.9	3.2	2.7	2.5	2.4
32.0	2.2	2.5	2.7	2.5	2.4	2.3
34.0	1.8	2.0	2.2	2.1	2.3	2.2
36.0	1.5	1.7	1.9	1.8	2.1	2.1
38.0	1.2	1.3	1.5	1.5	1.8	2.1
40.0	0.9	1.1	1.2	1.2	1.5	1.8
42.0	0.6	0.8	0.9	0.9	1.2	1.5
44.0		0.5	0.6	0.7	1.0	1.2
46.0					0.7	0.9
48.0						0.7
$\theta (^{\circ})$	49~ 82	48~ 82	50~ 82	56~ 82	56~ 82	57~ 82
標準フック	5.6t			5.6t		
フック重量	150kg			150kg		
標準巻掛本数	1			1		

注)カウンタウエイト 25t、アウトリガ張出幅 5.0m

油圧チルトジブ

【N性能】

11.1mブーム＋油圧チルトジブ

単位:t

ジブ長さ(m) 作業半径 (m)	10.0			18.0		
	オフセット			オフセット		
	5°	20°	40°	5°	20°	40°
3.0	11.0					
3.5	11.0					
4.0	11.0					
4.5	11.0					
5.0	11.0	11.0		5.6		
6.0	11.0	10.2		5.6		
7.0	11.0	9.4		5.6		
8.0	11.0	8.7	6.9	5.6		
9.0	10.1	8.1	6.6	5.6		
10.0	9.3	7.6	6.3	5.6	5.0	
11.0	8.6	7.2	6.1	5.6	4.7	
12.0	8.0	6.8	5.9	5.4	4.4	
14.0	7.0	6.2	5.5	4.7	4.0	
16.0	6.2	5.7		4.1	3.6	3.1
18.0				3.7	3.3	2.9
20.0				3.3	3.0	2.7
22.0				3.1	2.8	2.6
24.0				2.8	2.7	2.5
26.0				2.6	2.5	
θ (°)	33~ 82	38~ 82	54~ 82	20~ 82	28~ 82	47~ 82
標準フック	18t			5.6t		
フック重量	300kg			150kg		
標準巻掛本数	2			1		

注)カウンタウエイト 21t、アウトリガ張出幅 5.0m

【N性能】

33.2mブーム＋油圧チルトジブ

単位:t

ジブ長さ(m) 作業半径 (m)	10.0			18.0		
	オフセット			オフセット		
	5°	20°	40°	5°	20°	40°
8.0	10.1					
9.0	10.1					
10.0	10.1	8.9		4.2		
11.0	9.7	8.5		4.2		
12.0	9.3	8.1		4.2		
14.0	8.6	7.5	6.6	4.2		
16.0	8.0	7.0	6.2	4.2	4.2	
18.0	6.6	6.6	5.9	4.2	4.1	
20.0	5.4	5.8	5.6	4.2	3.9	3.2
22.0	4.4	4.8	5.2	4.2	3.8	3.0
24.0	3.7	4.0	4.3	4.2	3.6	2.9
26.0	3.0	3.3	3.5	3.6	3.5	2.9
28.0	2.4	2.7	2.9	3.1	3.4	2.8
30.0	2.0	2.2	2.3	2.6	3.0	2.7
32.0	1.6	1.7	1.9	2.2	2.5	2.6
34.0	1.2	1.4		1.8	2.1	2.4
36.0	0.9	1.0		1.5	1.7	2.0
38.0	0.6	0.7		1.2	1.4	1.6
40.0				0.9	1.1	1.3
42.0				0.7	0.9	
44.0					0.6	
θ (°)	24~ 82	27~ 82	46~ 82	36~ 82	35~ 82	47~ 82
標準フック	18t			5.6t		
フック重量	300kg			150kg		
標準巻掛本数	2			1		

注)カウンタウエイト 21t、アウトリガ張出幅 5.0m

【N性能】

47.9mブーム＋油圧チルトジブ

単位:t

ジブ長さ(m) 作業半径 (m)	10.0			18.0		
	オフセット			オフセット		
	5°	20°	40°	5°	20°	40°
11.0	4.9					
12.0	4.9					
14.0	4.9			2.9		
16.0	4.9	4.9		2.9		
18.0	4.9	4.7	4.4	2.9		
20.0	4.8	4.4	4.2	2.9	2.9	
22.0	4.5	4.2	4.0	2.9	2.9	
24.0	3.8	4.0	3.8	2.9	2.9	
26.0	3.2	3.5	3.7	2.9	2.9	2.7
28.0	2.6	2.9	3.2	2.9	2.8	2.6
30.0	2.1	2.4	2.6	2.5	2.6	2.5
32.0	1.7	1.9	2.2	2.0	2.5	2.4
34.0	1.4	1.6	1.7	1.7	2.0	2.3
36.0	1.0	1.2	1.4	1.4	1.7	2.1
38.0	0.8	0.9	1.1	1.1	1.4	1.7
40.0	0.5	0.6	0.8	0.8	1.1	1.4
42.0			0.5	0.6	0.8	1.1
44.0					0.6	0.8
46.0						0.6
θ (°)	49~ 82	50~ 82	49~ 82	55~ 82	56~ 82	56~ 82
標準フック	5.6t			5.6t		
フック重量	150kg			150kg		
標準巻掛本数	1			1		

注)カウンタウエイト 21t、アウトリガ張出幅 5.0m

【N性能】

51.2mブーム＋油圧チルトジブ

単位:t

ジブ長さ(m) 作業半径 (m)	10.0			18.0		
	オフセット			オフセット		
	5°	20°	40°	5°	20°	40°
12.0	4.4					
14.0	4.4					
16.0	4.4	4.4		2.7		
18.0	4.4	4.4		2.7		
20.0	4.4	4.1	3.9	2.7		
22.0	4.2	4.0	3.7	2.7	2.7	
24.0	3.8	3.8	3.6	2.7	2.7	
26.0	3.1	3.4	3.5	2.7	2.7	2.6
28.0	2.6	2.8	3.1	2.7	2.6	2.5
30.0	2.1	2.3	2.6	2.4	2.5	2.4
32.0	1.7	1.9	2.1	2.0	2.4	2.3
34.0	1.3	1.5	1.7	1.6	2.0	2.2
36.0	1.0	1.2	1.4	1.3	1.6	2.0
38.0	0.7	0.9	1.0	1.0	1.3	1.7
40.0		0.6	0.7	0.7	1.0	1.3
42.0				0.5	0.8	1.1
44.0					0.5	0.8
46.0						0.6
θ (°)	54~ 82	53~ 82	55~ 82	58~ 82	58~ 82	59~ 82
標準フック	5.6t			5.6t		
フック重量	150kg			150kg		
標準巻掛本数	1			1		

注)カウンタウエイト 21t、アウトリガ張出幅 5.0m

【O性能】

11.1mブーム+油圧チルトジブ 単位:t

ジブ長さ(m)	10.0			18.0		
	オフセット			オフセット		
作業半径(m)	5°	20°	40°	5°	20°	40°
3.0	11.0					
3.5	11.0					
4.0	11.0					
4.5	11.0					
5.0	11.0	11.0		5.6		
6.0	11.0	10.2		5.6		
7.0	11.0	9.4		5.6		
8.0	11.0	8.7	6.9	5.6		
9.0	10.1	8.1	6.6	5.6		
10.0	9.3	7.6	6.3	5.6	5.0	
11.0	8.6	7.2	6.1	5.6	4.7	
12.0	8.0	6.8	5.9	5.4	4.4	
14.0	7.0	6.2	5.5	4.7	4.0	
16.0	6.2	5.7		4.1	3.6	3.1
18.0				3.7	3.3	2.9
20.0				3.3	3.0	2.7
22.0				3.1	2.8	2.6
24.0				2.8	2.7	2.5
26.0				2.6	2.5	
θ(°)	33~82	38~82	54~82	20~82	28~82	47~82
標準フック	18t			5.6t		
フック重量	300kg			150kg		
標準巻掛本数	2			1		

注)カウンタウエイト 15t、アウトリガ張出幅 5.0m

【O性能】

33.2mブーム+油圧チルトジブ 単位:t

ジブ長さ(m)	10.0			18.0		
	オフセット			オフセット		
作業半径(m)	5°	20°	40°	5°	20°	40°
8.0	10.1					
9.0	10.1					
10.0	10.1	8.9		4.2		
11.0	9.7	8.5		4.2		
12.0	9.3	8.1		4.2		
14.0	8.2	7.5	6.6	4.2		
16.0	6.4	7.0	6.2	4.2	4.2	
18.0	5.1	5.5	5.9	4.2	4.1	
20.0	4.0	4.4	4.9	4.2	3.9	3.2
22.0	3.2	3.5	3.9	3.9	3.8	3.0
24.0	2.5	2.8	3.1	3.2	3.6	2.9
26.0	2.0	2.2	2.5	2.6	3.1	2.9
28.0	1.5	1.7	1.9	2.1	2.5	2.8
30.0	1.1	1.3	1.5	1.7	2.1	2.5
32.0	0.7	0.9	1.0	1.3	1.7	2.0
34.0		0.6		1.0	1.3	1.6
36.0				0.7	1.0	1.3
38.0				0.5	0.7	0.9
40.0					0.5	0.6
θ(°)	41~82	39~82	46~82	44~82	44~82	47~82
標準フック	18t			5.6t		
フック重量	300kg			150kg		
標準巻掛本数	2			1		

注)カウンタウエイト 15t、アウトリガ張出幅 5.0m

【O性能】

47.9mブーム+油圧チルトジブ 単位:t

ジブ長さ(m)	10.0			18.0		
	オフセット			オフセット		
作業半径(m)	5°	20°	40°	5°	20°	40°
11.0	4.9					
12.0	4.9					
14.0	4.9			2.9		
16.0	4.9	4.9		2.9		
18.0	4.9	4.7	4.4	2.9		
20.0	4.2	4.4	4.2	2.9	2.9	
22.0	3.4	3.8	4.0	2.9	2.9	
24.0	2.7	3.0	3.4	2.9	2.9	
26.0	2.1	2.4	2.7	2.5	2.9	2.7
28.0	1.6	1.9	2.2	2.0	2.5	2.6
30.0	1.2	1.5	1.7	1.6	2.0	2.5
32.0	0.9	1.1	1.3	1.2	1.6	2.1
34.0		0.8	1.0	0.9	1.3	1.7
36.0			0.6	0.6	1.0	1.3
38.0					0.7	1.0
40.0						0.7
42.0						0.5
θ(°)	59~82	58~82	58~82	61~82	63~82	61~82
標準フック	5.6t			5.6t		
フック重量	150kg			150kg		
標準巻掛本数	1			1		

注)カウンタウエイト 15t、アウトリガ張出幅 5.0m

【O性能】

51.2mブーム+油圧チルトジブ 単位:t

ジブ長さ(m)	10.0			18.0		
	オフセット			オフセット		
作業半径(m)	5°	20°	40°	5°	20°	40°
12.0	4.4					
14.0	4.4					
16.0	4.4	4.4		2.7		
18.0	4.4	4.4		2.7		
20.0	4.2	4.1	3.9	2.7		
22.0	3.3	3.7	3.7	2.7	2.7	
24.0	2.6	3.0	3.4	2.7	2.7	
26.0	2.1	2.4	2.7	2.4	2.7	2.6
28.0	1.6	1.9	2.2	1.9	2.4	2.5
30.0	1.2	1.4	1.7	1.5	2.0	2.4
32.0	0.8	1.1	1.3	1.1	1.6	2.0
34.0			0.9	0.8	1.2	1.6
36.0					0.9	1.3
38.0					0.6	1.0
40.0						0.7
θ(°)	61~82	63~82	63~82	66~82	65~82	66~82
標準フック	5.6t			5.6t		
フック重量	150kg			150kg		
標準巻掛本数	1			1		

注)カウンタウエイト 15t、アウトリガ張出幅 5.0m

油圧チルトジブ

【P性能】

11.1mブーム＋油圧チルトジブ

単位:t

ジブ長さ(m) 作業半径 (m)	10.0			18.0		
	オフセット			オフセット		
	5°	20°	40°	5°	20°	40°
3.0	11.0					
3.5	11.0					
4.0	11.0					
4.5	11.0					
5.0	11.0	11.0		5.6		
6.0	11.0	10.2		5.6		
7.0	11.0	9.4		5.6		
8.0	11.0	8.7	6.9	5.6		
9.0	10.1	8.1	6.6	5.6		
10.0	9.3	7.6	6.3	5.6	5.0	
11.0	8.6	7.2	6.1	5.6	4.7	
12.0	8.0	6.8	5.9	5.4	4.4	
14.0	7.0	6.2	5.5	4.7	4.0	
16.0	5.9	5.7		4.1	3.6	3.1
18.0				3.7	3.3	2.9
20.0				3.3	3.0	2.7
22.0				3.1	2.8	2.6
24.0				2.8	2.7	2.5
26.0				2.6	2.5	
$\theta (^{\circ})$	33~ 82	38~ 82	54~ 82	20~ 82	28~ 82	47~ 82
標準フック	18t			5.6t		
フック重量	300kg			150kg		
標準巻掛本数	2			1		

注)カウンタウエイト 9t、アウトリガ張出幅 5.0m

【P性能】

33.2mブーム＋油圧チルトジブ

単位:t

ジブ長さ(m) 作業半径 (m)	10.0			18.0		
	オフセット			オフセット		
	5°	20°	40°	5°	20°	40°
8.0	10.1					
9.0	10.1					
10.0	10.1	8.9		4.2		
11.0	9.7	8.5		4.2		
12.0	8.2	8.1		4.2		
14.0	6.1	6.7	6.6	4.2		
16.0	4.6	5.1	5.8	4.2	4.2	
18.0	3.4	3.9	4.5	4.2	4.1	
20.0	2.6	3.0	3.4	3.3	3.9	3.2
22.0	1.9	2.3	2.6	2.6	3.2	3.0
24.0	1.3	1.7	2.0	2.0	2.6	2.9
26.0	0.9	1.2	1.4	1.5	2.0	2.6
28.0		0.7	0.9	1.1	1.6	2.0
30.0			0.5	0.8	1.2	1.6
32.0				0.5	0.8	1.2
34.0					0.5	0.8
36.0						0.5
$\theta (^{\circ})$	52~ 82	51~ 82	50~ 82	53~ 82	54~ 82	55~ 82
標準フック	18t			5.6t		
フック重量	300kg			150kg		
標準巻掛本数	2			1		

注)カウンタウエイト 9t、アウトリガ張出幅 5.0m

【P性能】

47.9mブーム＋油圧チルトジブ

単位:t

ジブ長さ(m) 作業半径 (m)	10.0			18.0		
	オフセット			オフセット		
	5°	20°	40°	5°	20°	40°
11.0	4.9					
12.0	4.9					
14.0	4.9			2.9		
16.0	4.8	4.9		2.9		
18.0	3.7	4.2	4.4	2.9		
20.0	2.8	3.2	3.7	2.9	2.9	
22.0	2.1	2.5	2.9	2.5	2.9	
24.0	1.5	1.9	2.2	1.9	2.5	
26.0	1.1	1.4	1.7	1.4	2.0	2.6
28.0		0.9	1.2	1.0	1.5	2.1
30.0					1.1	1.6
32.0					0.8	1.2
34.0						0.9
$\theta (^{\circ})$	66~ 82	65~ 82	68~ 82	69~ 82	69~ 82	70~ 82
標準フック	5.6t			5.6t		
フック重量	150kg			150kg		
標準巻掛本数	1			1		

注)カウンタウエイト 9t、アウトリガ張出幅 5.0m

【P性能】

51.2mブーム＋油圧チルトジブ

単位:t

ジブ長さ(m) 作業半径 (m)	10.0			18.0		
	オフセット			オフセット		
	5°	20°	40°	5°	20°	40°
12.0	4.4					
14.0	4.4					
16.0	4.4	4.4		2.7		
18.0	3.6	4.1		2.7		
20.0	2.7	3.2	3.7	2.7		
22.0	2.0	2.4	2.9	2.4	2.7	
24.0	1.5	1.8	2.2	1.8	2.4	
26.0		1.3	1.6	1.3	1.9	2.5
28.0			1.2	0.9	1.4	2.0
30.0					1.1	1.6
32.0						1.2
34.0						0.8
$\theta (^{\circ})$	70~ 82	69~ 82	70~ 82	71~ 82	72~ 82	72~ 82
標準フック	5.6t			5.6t		
フック重量	150kg			150kg		
標準巻掛本数	1			1		

注)カウンタウエイト 9t、アウトリガ張出幅 5.0m

【Q性能】

11.1mブーム+油圧チルトジブ 単位:t

ジブ長さ(m) 作業半径 (m)	10.0			18.0		
	オフセット			オフセット		
	5°	20°	40°	5°	20°	40°
3.0	11.0					
3.5	11.0					
4.0	11.0					
4.5	11.0					
5.0	11.0	11.0		5.6		
6.0	11.0	10.2		5.6		
7.0	11.0	9.4		5.6		
8.0	11.0	8.7	6.9	5.6		
9.0	10.1	8.1	6.6	5.6		
10.0	9.3	7.6	6.3	5.6	5.0	
11.0	8.6	7.2	6.1	5.6	4.7	
12.0	7.8	6.8	5.9	5.4	4.4	
14.0	5.9	6.2	5.5	4.7	4.0	
16.0	4.6	4.8		4.1	3.6	3.1
18.0				3.7	3.3	2.9
20.0				3.3	3.0	2.7
22.0				3.1	2.8	2.6
24.0				2.6	2.7	2.5
26.0				2.2	2.3	
θ (°)	33~ 82	38~ 82	54~ 82	20~ 82	28~ 82	47~ 82
標準フック	18t			5.6t		
フック重量	300kg			150kg		
標準巻掛本数	2			1		

注)カウンタウエイト 5t、アウトリガ張出幅 5.0m

【Q性能】

33.2mブーム+油圧チルトジブ 単位:t

ジブ長さ(m) 作業半径 (m)	10.0			18.0		
	オフセット			オフセット		
	5°	20°	40°	5°	20°	40°
8.0	10.1					
9.0	10.1					
10.0	9.2	8.9		4.2		
11.0	7.6	8.5		4.2		
12.0	6.4	7.2		4.2		
14.0	4.6	5.2	6.0	4.2		
16.0	3.3	3.8	4.5	4.1	4.2	
18.0	2.3	2.8	3.3	3.1	3.9	
20.0	1.6	2.0	2.4	2.3	3.0	3.2
22.0	1.0	1.4	1.7	1.7	2.3	3.0
24.0		0.8	1.2	1.2	1.8	2.4
26.0				0.8	1.3	1.8
28.0					0.9	1.4
30.0					0.5	1.0
32.0						0.6
θ (°)	59~ 82	58~ 82	62~ 82	62~ 82	60~ 82	62~ 82
標準フック	18t			5.6t		
フック重量	300kg			150kg		
標準巻掛本数	2			1		

注)カウンタウエイト 5t、アウトリガ張出幅 5.0m

【Q性能】

47.9mブーム+油圧チルトジブ 単位:t

ジブ長さ(m) 作業半径 (m)	10.0			18.0		
	オフセット			オフセット		
	5°	20°	40°	5°	20°	40°
11.0	4.9					
12.0	4.9					
14.0	4.8			2.9		
16.0	3.5	4.1		2.9		
18.0	2.5	3.0	3.6	2.9		
20.0	1.8	2.2	2.7	2.2	2.9	
22.0		1.6	2.0	1.6	2.3	
24.0			1.4	1.1	1.7	
26.0					1.2	1.8
28.0						1.4
30.0						1.0
θ (°)	73~ 82	72~ 82	72~ 82	73~ 82	75~ 82	75~ 82
標準フック	5.6t			5.6t		
フック重量	150kg			150kg		
標準巻掛本数	1			1		

注)カウンタウエイト 5t、アウトリガ張出幅 5.0m

【Q性能】

51.2mブーム+油圧チルトジブ 単位:t

ジブ長さ(m) 作業半径 (m)	10.0			18.0		
	オフセット			オフセット		
	5°	20°	40°	5°	20°	40°
12.0	4.4					
14.0	4.4					
16.0	3.5	4.0		2.7		
18.0	2.5	3.0		2.7		
20.0	1.7	2.2	2.7	2.1		
22.0		1.5	2.0	1.5	2.2	
24.0			1.4		1.6	
26.0					1.2	1.8
28.0						1.3
θ (°)	74~ 82	74~ 82	74~ 82	77~ 82	76~ 82	78~ 82
標準フック	5.6t			5.6t		
フック重量	150kg			150kg		
標準巻掛本数	1			1		

注)カウンタウエイト 5t、アウトリガ張出幅 5.0m